

Review of the Current State of Genetic Testing - A Living Resource

Prepared by

Liza Gershony, DVM, PhD and Anita Oberbauer, PhD

of the

University of California, Davis

Editorial input by

Leigh Anne Clark, PhD

of

Clemson University

Contents

Introduction	1
I. The Basics	2
II. Modes of Inheritance	7
a. Mendelian Inheritance and Punnett Squares	7
b. Non-Mendelian Inheritance	10
III. Genetic Selection and Populations	13
IV. Dog Breeds as Populations	15
V. Canine Genetic Tests	16
a. Direct and Indirect Tests	17
b. Single versus Multipanel Tests	18
VI. Interpretation of DNA Test Results	18
VII. Diversity Testing	20
VIII. Breed Specificity of Genetic Tests	22
IX. Applications of Genetic Tests	23
X. Genetic Test Providers and Oversight of Genetic Testing	26
XI. Caution Regarding Test Interpretation	28
XII. Impact of Genetic Testing	29
XIII. Future Advances	30
XIV. Closing Thoughts	31
Glossary	31
References	35

Introduction

Genetic tests for dog traits, that is their physical characteristics, and diseases have become increasingly available over the past few years, offering exciting opportunities for improving the health of dogs at both individual and population levels. Dog owners and breeders have long dreamed of having genetic tools to allow them to determine if a dog is predisposed to any genetic diseases and/or to make educated breeding decisions that will improve the health of future generations. While the increasing availability of these tools is exciting, many genetic test results are difficult to interpret and can lead to confusion. Proper interpretation of genetic test results and understanding the limitations of a test are important to avoid their misapplication, which can cause unnecessary concern and expense to dog owners (*e.g.*, clinical exams, dietary modifications). Moreover, the misapplication of genetic test results in breeding programs could lead to excessive neutering and unnecessary removal of individuals from the breeding population, which can negatively impact genetic variability within a breed, rather than improve its overall health.

The present document was supported by collaborative funding provided by the Orthopedic Foundation for Animals and the American Kennel Club Canine Health Foundation with the goal of providing dog owners, breeders, and veterinarians with a foundation in canine genetics to help interpret and understand the implications of genetic test results. The information in this document is intended to help users of genetic tests determine which (if any) changes should be adopted to improve a dog's quality of life and wellbeing. The document is designed to be a "living resource" that will be updated as new information becomes available and is accompanied by a glossary of genetic terms and didactic videos that will help the reader better understand important genetic concepts. The types of genetic tests currently in use, their application in breeding programs and their limitations will be discussed as well as potential detrimental effects of the misapplication of test results in both pet and breeding dogs. Finally, the future of genetic testing in dogs will be discussed as well as any anticipated limitations.

I. The Basics

To understand the nuances of genetic testing, one must have a good grasp of the basics of genetics and inheritance. This section will address the structure of a dog's genetic material, how it determines different physical characteristics, and the different ways that genes are passed on from parents to their puppies. An accompanying video can be found [here](#).

a. DNA and Chromosomes

A dog is made up of trillions of cells. Within most cells is a compartment (the nucleus) containing the dog's genetic material. The genetic material, also referred to as the genome, is in many ways equivalent to an instruction manual and dictates how that dog will grow, what it will look like, how well it will process certain food items and, to some extent, how it will behave and reproduce.

A dog's genome is made up of long molecules of DNA, composed of two strands wound around each other in the form of a double helix and tightly packed to form structures called chromosomes (Figure 1). The DNA molecule making up a chromosome is composed of building blocks called nucleotides. There

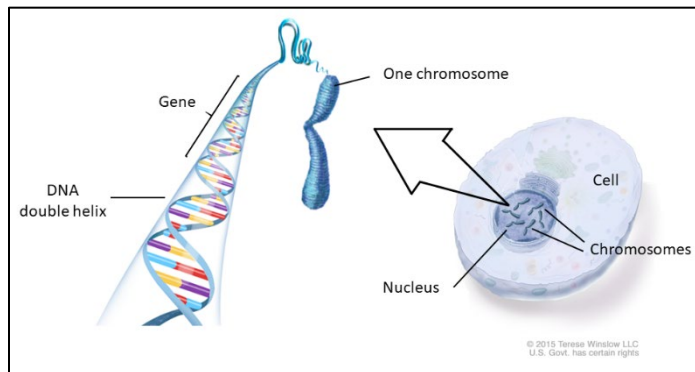

are four types of nucleotides (sometimes referred to as bases) and they are abbreviated A, C, T and G. In total, a dog has nearly 3 billion of these nucleotides arranged in a specific sequence that allows the DNA to be used as an instruction manual.

Figure 1: Localization and structure of a dog's genetic material or genome.

There are many distinct chromosomes within a nucleus, and they differ in length and DNA content. Chromosomes exist in pairs, meaning that every cell has two copies of each of the chromosomes that make up the dog's genome: one copy of each chromosome came from the dog's mother and one copy came from its father. Dogs have 39 pairs of chromosomes, where one pair makes up the sex chromosomes and all non-sex chromosomes (*i.e.*, the 38 remaining pairs) are called autosomes. Sex chromosomes determine the sex of an individual; if the sex chromosomes are XX then the puppy is female and if XY then the puppy is male.

b. Cell Division and Sexual Reproduction

To maintain healthy tissues and organs, cells of the body are constantly replacing old or damaged cells through cell division, where a cell will create an exact duplicate of itself. Reproductive cells go through a specialized form of cell division, called meiosis, to form the egg and sperm (Figure 2). In meiosis, first all the chromosomes are copied so the cell has four copies of each chromosome. Then, through a process called recombination, some of the chromosomes swap segments of DNA with each other. After this process, two of the chromosomes will be the same as the original and two will be different because they have been "recombined." The cell then divides those four chromosomes into separate cells to form the

gametes—the egg, in the case of females, and the sperm, in the case of males. We will use the general term “gamete” to mean either the egg or the sperm throughout this document.

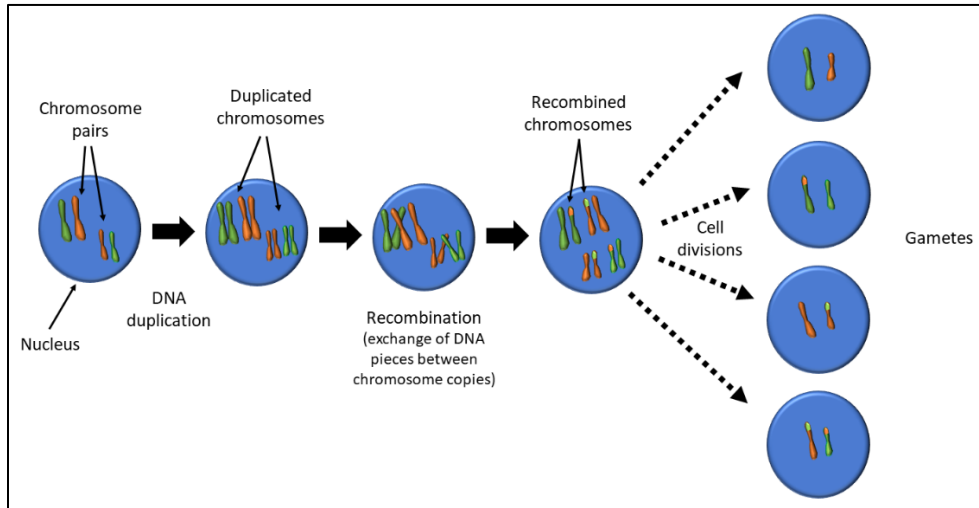

Figure 2: Simplified illustration of the process of DNA duplication and recombination that occur in the nucleus of a reproductive cell undergoing meiosis for the formation of gametes. Only two of the 39 chromosome pairs are represented.

Through the specialized cell division of meiosis, the gametes only receive one copy of each chromosome. During sexual reproduction, the female’s egg is combined with the male’s sperm to form a new cell that will then contain two copies of each chromosome, one coming from the mother and one from the father (Figure 3). This new cell, called a zygote, now has the necessary blueprint to create a puppy that will be different from either parent [1]. A video about gamete formation is found [here](#).

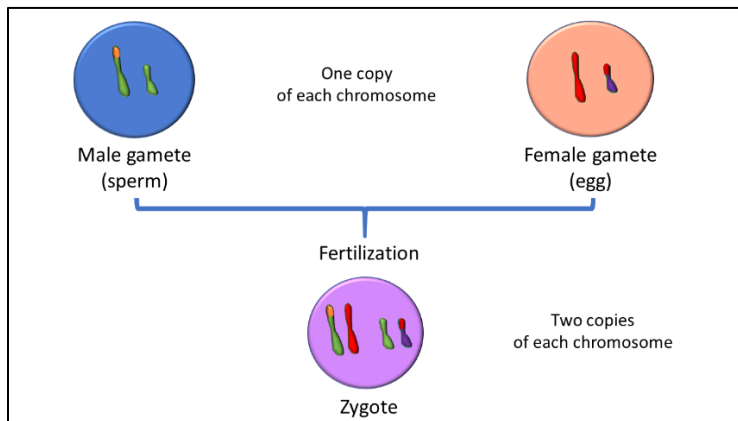

Figure 3: Simplified illustration of fertilization showing the nucleus of two gametes (one male, one female) that combine to form a diploid cell (zygote). The zygote will give rise to a puppy.

c. Traits, Genes and Alleles

Along the chromosome are regions of DNA that represent genes. At this time, there are believed to be about 19,000 different genes in the dog, but as we learn more, that may change in the future. Each chromosome contains hundreds of genes and each gene is at a specific location on a chromosome. The

specific location is referred to as a “locus,” which can be thought of as the street address of the gene. The specific order of the nucleotides provides instructions for making up a product that composes a particular trait. For the purpose of this document, a trait is any physical characteristic that can be passed on from parents to their puppies, and the observable expression of a trait will be referred to as a phenotype throughout this document because some traits have more than one phenotype (*e.g.*, eye color). Some phenotypes may not be desirable, such as a disease or a particular coat color that does not comply with the breed standard.

Let us consider genes and their DNA sequences in the framework of fur traits. Hair/fur has many different attributes: it can be long or short, straight or curly or wiry, and it could have rich color or pale color or no color -- all of those characteristics combine into what we observe as a dog’s coat. Yet, in actuality, what we are seeing is a collection of many different phenotypes, each governed by a different gene. For example, fur length is a trait and long fur is one possible phenotype of that trait. Similarly, fur color is a trait and black fur is a possible phenotype of that trait. While all dogs have the same genes, the observed phenotype can vary.

When a cell duplicates itself, the genetic material of that cell is also duplicated. Though the machinery responsible for copying the DNA is extremely efficient and accurate, mistakes can happen, resulting in a change to the original DNA sequence of that cell. These mistakes can be thought of somewhat like typographical errors: there could be one or more extra nucleotides included in the original DNA sequence, or one or more nucleotides could be substituted or even missing. These mistakes that happen during the copying of a cell’s DNA are referred to as mutations or genetic variants. When a variant is just a single nucleotide difference in the DNA sequence, it is called a single nucleotide polymorphism (SNP, pronounced “snip”). When parts of the DNA are missing, it is called a deletion (DEL for short) and when more sequence is added in, it is called an insertion (INS for short). The DNA change is called a variant because the sequence “varies” from a reference sequence. For the dog, the genome reference sequence is that of a female boxer sequenced in 2005 [2].

Although some variants may not alter the function of a DNA sequence, others can change the instructions contained in a gene such that a slightly different protein will be produced and a different phenotype observed when compared to the original phenotype or “wildtype.” Now going back to the fur example, one of many genes that can determine fur color is the tyrosinase related protein 1 (*TYRP1*) gene, also known as the B-locus. As an aside, the term “locus” is sometimes used when the gene governing a trait has not yet been discovered. For example, the term B-locus was used before *TYRP1* was identified, and even though the gene is now known, it is still commonly called the B-locus because that name is easier to remember. The *TYRP1* gene provides instructions for producing black pigment that makes the fur look black. Figure 4 shows the two existing forms of the *TYRP1* gene, one resulting in a black fur phenotype (*i.e.*, the wildtype version of that gene) and another resulting in brown fur (*i.e.*, a variant form of that gene). The different fur colors are produced by the same gene, but the actual DNA sequence is slightly different. The different forms of a same gene are called alleles.

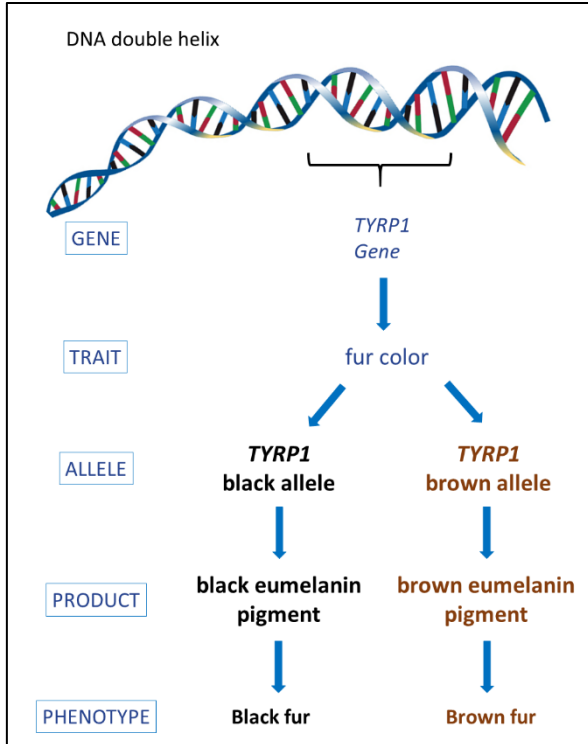

Figure 4: DNA structure, its building blocks and an example of how different forms of a same gene can produce distinct phenotypes.

Although there may be many different alleles for a gene within a population, an individual dog can have at most two alleles for every gene: one allele it inherited from its mother and one that it inherited from its father. The combination of the two alleles a dog has for a gene is called a genotype. When a puppy receives the exact same allele from its father and its mother it is said to be homozygous for that allele and have a homozygous genotype for that gene (Figure 5). Alternatively, a puppy that receives different alleles from its mother and father, is said to be heterozygous and have a heterozygous genotype for that gene.

Since every individual dog carries exactly two alleles for every one of their genes, what happens when the alleles are different? What color would a dog's fur be if it had one brown and one black allele of the *TYRP1* gene? The phenotype of dogs with two different alleles depends on the relationship between those two alleles and the protein products produced by them. Certain alleles are completely dominant, and their phenotype is always expressed over other alleles. This is the case for the black allele of the *TYRP1* gene. This means that every dog that has at least one black allele for the *TYRP1* gene will display black fur, even if the second allele is the brown allele. Dominant alleles are represented by an uppercase letter (e.g., B; Figure 5). Note that in this particular

case, the dominant allele is also the wildtype allele, but this is not always the case. Some genes have wildtype alleles that behave as recessive alleles.

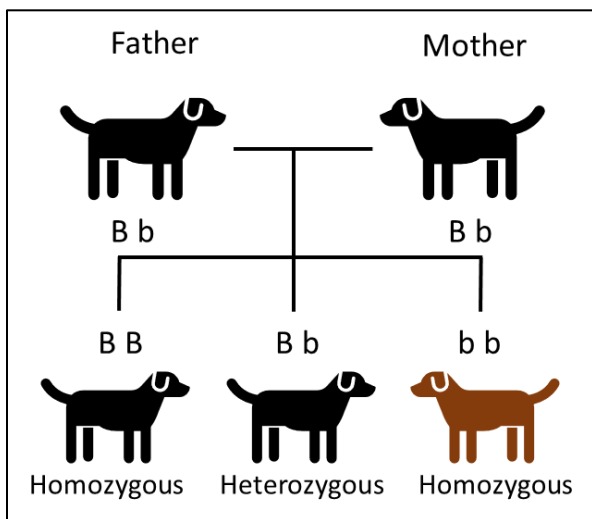

Figure 5: Pedigree (or family tree) demonstrating the inheritance of the *TYRP1* gene in the dog. Puppies receiving the same allele from both parents will have a homozygous genotype; those homozygous dominant (i.e., BB) will have black fur and those homozygous recessive (i.e., bb) will have brown fur. Puppies receiving different alleles from mom and dad will have a heterozygous genotype and black fur because the black fur allele is completely dominant over the brown allele. Heterozygous black dogs carry the recessive allele and can pass it on to the next generation.

Since the brown color is not seen when the black dominant allele is present, the brown allele is said to be recessive. Recessive alleles are represented by a lowercase letter (e.g., b), and a dog needs to have two

recessive brown alleles (*i.e.*, the *bb* genotype) to have brown fur. Conversely, dogs only need one black allele to have black fur, meaning that black dogs can have a homozygous dominant genotype (*i.e.*, *BB*) or a heterozygous genotype (*i.e.*, *Bb*). The terms dominant and recessive are also used to describe the mode of inheritance of a phenotype, which will be addressed in section II.

Some genes like *TYRP1* only exist in two forms in the canine population, but other genes (such as the gene for white spotting or agouti) may have more than two alleles, each resulting in a different phenotype. The existence of more than two alleles for a gene is often referred to as an allelic series and there may be a hierarchy of dominance across the different alleles. An example of this is described [here](#).

The alleles of a given gene can determine desirable traits, undesirable traits, or even disease traits. Though people often talk about a dog having a “bad” gene for a trait, in actuality, the dog has “bad” alleles for the gene governing that trait. And a group of dogs can have many different alleles. The abundance of the different possible alleles within a population is referred to as allele frequency. The more abundant an allele is, the higher the frequency and the more likely the phenotype associated with that allele will be observed in the population. For example, the allele governing short fur will have a very high frequency within the population of a dog breed that is characterized by short fur.

During the formation of breeds, breeders purposely increased the frequencies of alleles that caused breed-defining phenotypes. When there is no allele variability for a breed-defining trait, then all puppies from any parents of that breed will also have those same breed-defining traits. Alleles are said to be “fixed” in a breed when there is only one allele in the breed population (*i.e.*, no variation). For example, the *B* allele of the *TYRP1* gene is fixed in the Flat Coat Retriever, in which black is a breed-defining phenotype. Conversely, *TYRP1* is variable in the Labrador Retriever. Since both alleles can be found in the Labrador Retriever breed population, it is possible to have black Labradors that are *BB* or *Bb*, and brown/chocolate Labradors that are *bb*.

d. Genes, Linkage and Recombination

As described above, a process called recombination takes place during gamete formation, so that some chromosome copies will swap segments of DNA with each other and become recombined. The DNA segments swapped correspond to the same region of both chromosomes, and thus contain the same genes; however, each chromosome of a pair could have a different allele for a swapped gene. Recombination is a random event that can take place at any location on a chromosome and is an important mechanism for creating genetic diversity by shuffling the alleles between chromosome pairs.

An important concept to understand though is that the closer two genes are to each other on the same chromosome, the lower the chances are that recombination will happen in between them to shuffle their alleles. This is why the alleles of genes that are physically close to one another on a chromosome tend to be inherited together and are said to be “linked.” Though it is possible that recombination could happen in between two linked genes, thus breaking that “linkage”, it is very unlikely given their close proximity. A visual illustration of linkage and recombination can be found [here](#).

II. Modes of Inheritance

a. Mendelian Inheritance and Punnett Squares

Mode of inheritance (or inheritance pattern) refers to how a trait is transmitted from parents to offspring across generations. While studying pea plants, the geneticist Gregor Mendel observed phenotype and characterized aspects of inheritance that are now referred to as Mendelian inheritance. The term “Mendelian” is typically used to describe traits that are governed by a single gene (i.e. monogenic) where one allele displays complete dominance over another (like the black and brown fur color described above). The patterns of Mendelian inheritance are described next. Two accompanying videos describe [autosomal](#) and [sex-linked](#) modes of inheritance.

i. Autosomal Dominant

As a reminder, there are 39 pairs of chromosomes and 38 are autosomes and 1 pair is the sex chromosomes. Autosomal dominant refers to the inheritance of a phenotype that is caused by a completely dominant allele for a gene located on one of the autosomes. For example, the black fur color described previously can be caused by an autosomal dominant allele at the *TYRP1* gene, or the B-locus, which is located on canine chromosome 11 – an autosome. When examining a family tree or pedigree that shows the inheritance pattern of an autosomal dominant phenotype, such as the black fur governed by the *TYRP1* gene, we will see that the dominant phenotype appears in every generation (Figure 6). If at least one of the parents displays the dominant phenotype, there is at least a 50% chance that one of its puppies will too. How to determine the statistical probability of dominant phenotypes being present in a litter is discussed [here](#).

ii. Autosomal Recessive

Autosomal recessive refers to the inheritance of a phenotype that is caused by a recessive allele of a gene located on one of the autosomes. Therefore, the observable phenotype expression requires two of those same recessive alleles (*i.e.*, a homozygous recessive genotype). This is because recessive alleles are easily “overridden” by the presence of a dominant allele. As described above, the brown fur color has an autosomal recessive mode of inheritance, and only dogs possessing two of these recessive alleles at the B-locus will appear brown. When examining a family tree or pedigree that shows the inheritance pattern of an autosomal recessive phenotype, such as the brown fur governed by the B-locus, we will notice that, unlike the dominant phenotype, a recessive phenotype does not usually appear in every generation (“skips a generation”). As seen in figure 6, there may be litters where both parents have black fur and a brown puppy is produced. This is because black dogs can have a heterozygous genotype, which means that although they display a dominant phenotype, they are carriers for the recessive brown allele. How to determine the statistical probability of recessive phenotypes being present in a litter when we know the parent genotypes is discussed [here](#).

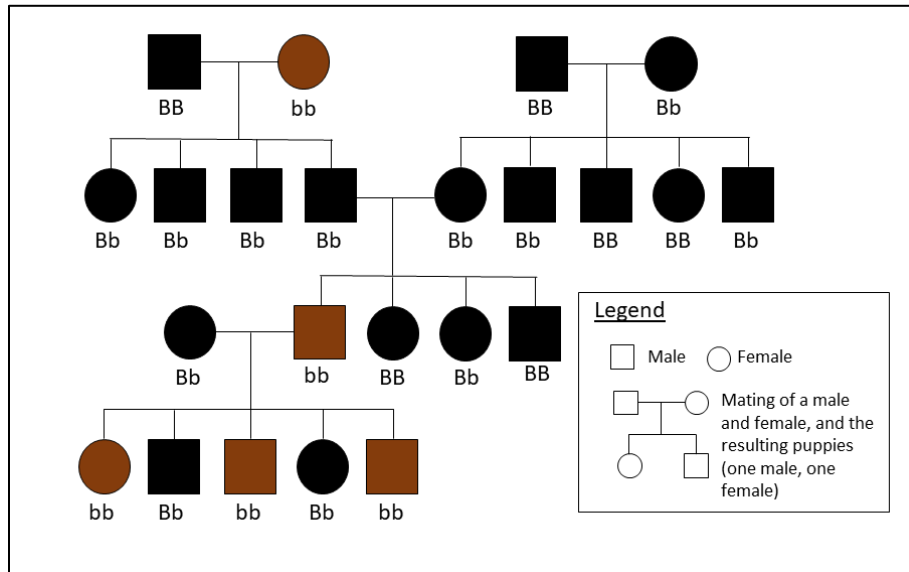

Figure 6: A pedigree (family tree) for black and brown fur color as determined by the *TYRP1* gene. Genotypes are noted under each dog: BB – homozygous dominant (black), Bb – heterozygous (black), and bb – homozygous recessive (brown). Note, in this example, the dominant phenotype (black fur) can be seen in every generation, whereas the recessive genotype can skip generations.

iii. Sex-linked

As mentioned earlier, one pair of chromosomes is referred to as sex chromosomes because they are responsible for determining the sex of a dog: female dogs are XX (*i.e.*, have two X chromosomes) and male dogs are XY (*i.e.*, have one X and one Y chromosome). Only a few traits have been attributed to genes found on the sex chromosomes of dogs. The “dominant” and “recessive” terms apply to sex-linked phenotypes in the same way they do to autosomal traits, but the phenotypic outcome will depend on the dog’s sex.

Since female dogs have two X chromosomes, expression of a dominant or recessive phenotype will mostly follow the same patterns described for autosomal traits: dominant traits will manifest in females that are homozygous or heterozygous for the gene, whereas recessive traits will only be seen in females with two recessive alleles for the gene (*i.e.* homozygous recessive). Males, however, only have one X chromosome. This means that, in males, a single allele on the X chromosome will govern expression of the X-linked trait. In that case a single recessive allele can cause the expression of a trait in males because they will have no other allele that could “override” that recessive allele.

For example, [hemophilia B](#), an X-linked recessive disorder that causes prolonged bleeding in affected dogs, is seen in the German Wirehaired Pointer breed. Because the *Factor IX* gene that governs this disorder is on the X chromosome, all male dogs having the recessive disease-causing allele will show clinical signs of the disorder. Females, however, may be heterozygous and have one normal dominant allele and one disease-causing recessive allele and they will not exhibit the disorder. Though heterozygous females will not develop the disorder, they may pass a disease-causing recessive allele to their puppies. A female known to have produced an affected puppy when mated to a healthy male is an obligate carrier of the allele causing hemophilia B.

While the Y chromosome also contains genes, it is physically much smaller than the X chromosome and contains fewer genes. Traits or disorders governed by genes located on the Y chromosome will only affect males because females lack a Y, and so these genes are only passed on from a father (sire) to its male puppies. To date, no Y-linked health conditions have been reported in dogs.

It is important to clarify that sex-linked traits are not the same as sex-limited traits. Sex-limited traits are those that can only be observed in one of the sexes. For example, cryptorchidism, characterized by one or both testicles failing to descend through the inguinal canal within the first few months of a puppy's life, is a disorder that can only be observed in male dogs. Cryptorchidism is a sex-limited trait (and not sex-linked) because, although it is seen only in male dogs, it has an autosomal mode of inheritance [3]. Genetic studies indicate that cryptorchidism is governed by more than one autosomal gene, although no causative genes have been identified to date [4]. Therefore, female dogs can have cryptorchidism-causing alleles, however their status will not be observable because they do not have testicles.

iv. Punnett Squares and Phenotype Prediction

For Mendelian traits, once we know the inheritance pattern of a trait, we can use the parent information to predict all possible genotypes and phenotypes of puppies. We can do this with the help of a table containing four quadrants, commonly referred to as a Punnett square. At the top of the table, we list the alleles that the mother's gametes would have, and on the side of the table we list the alleles that the father's gametes possess. The quadrants are then filled in with one gamete from each parent (simulating fertilization) and will reveal all possible combinations a puppy from that breeding could inherit. The proportion of homozygous dominant, heterozygous, and/or homozygous recessive genotypes that may be seen in the puppies is then used to estimate the chance of seeing each of the possible phenotypes in the resulting litter. For example, as shown in Figure 6, if we consider a breeding between a male heterozygous for a given gene (Aa) and a female homozygous for recessive alleles at that same gene (aa), after simulating fertilization, two of the quadrants will have a puppy with a heterozygous genotype and two other quadrants will have a puppy with a homozygous recessive genotype. This means there is a 50% chance of a puppy in a litter from that breeding exhibiting the dominant phenotype and a 50% chance that a puppy will exhibit the recessive phenotype. For more information and examples, please refer to the Punnett square video. Additionally, when we look at more than one gene simultaneously, the number of quadrants expands in the Punnett square proportional to the number of possible gametes and can get very complicated. For more

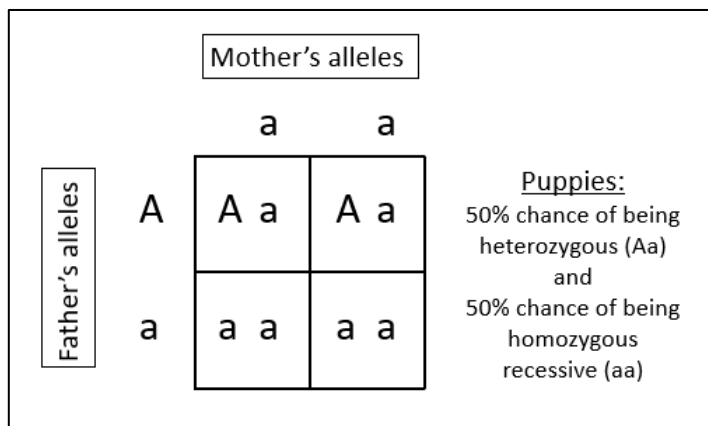

examples of how Punnett squares can be used, refer to this [video](#).

Figure 6: A Punnett square showing all possible genotype combinations for a breeding between a heterozygous male (Aa) and a homozygous recessive female (aa). Puppies obtained from this breeding would have a 50% chance of being heterozygous and a 50% chance of being homozygous recessive.

b. Non-Mendelian Inheritance

Knowledge of Mendelian inheritance helps us understand how traits can be passed from a father or mother to their puppies. However, as noted in other mammals, many dog traits do not play by Mendel's rules due to various reasons, which makes it difficult to assess their mode of inheritance by looking at pedigrees. It is also harder to identify the causal genes behind these traits. When available, genetic testing for such traits need to be interpreted with more caution as they may not be able to capture all determining factors underlying the trait. The following types of non-Mendelian inheritance have been described and a brief explanation of each with visual examples can be found [here](#).

i. Incomplete Dominance

Incomplete dominance occurs in the absence of a recessive/dominant relationship between the different alleles of a gene. However, in this case, heterozygous dogs display a mixture of the two possible phenotypes (i.e. an intermediate phenotype that appears to be a blend between the two phenotypes caused by each of the alleles).

The merle coat color is an example of incomplete dominance [5]. Two alleles exist for this gene, designated as uppercase M and lowercase m. Despite the use of uppercase and lowercase letters to designate the two alleles, there is no dominant/recessive relationship between the two alleles. Dogs homozygous mm display full expression of color on their fur whereas dogs homozygous MM are almost all white and can additionally have associated defects, such as deafness (see the section on pleiotropy below). Dogs heterozygous for the merle allele (Mm), however, will display an intermediate phenotype with areas of full pigmentation intertwined with areas of light pigmentation producing a marble-like pattern [6].

ii. Incomplete Penetrance

Penetrance refers to the proportion of the dogs who have a particular genotype that actually display the associated phenotype. Complete penetrance means that every dog with that genotype will express the associated phenotype, whereas incomplete penetrance means that only a portion of the dogs carrying that genotype will display the expected phenotype. The rare condition of a mild and disproportionate dwarfism in Labrador Retrievers is caused by a mutation in a collagen gene (*COL11A2*) that has incomplete penetrance [7]. When known, traits having incomplete penetrance can also be characterized by the percentage of dogs with the genotype who actually display the trait. For example, a dominant mutation in the gap junction protein alpha 9 (*GJA9*) gene has been associated with polyneuropathy in Leonbergers and has an 80% penetrance, meaning that 80% of dogs with the mutation show clinical signs of the disorder[8].

iii. Multiple Alleles

In many cases, more than two forms of a gene (that is, alleles) exist within a population, resulting in multiple possible phenotypes depending on which combination of alleles a dog possesses and how those alleles relate to one another. A good example of this is the S-locus (microphthalmia-associated transcription factor (*MITF*) gene), which determines most of the white spotting patterns of dogs. Four alleles have been identified exhibiting a dominance hierarchy: the most dominant allele is the S allele that causes a solid-colored coat color; the second in the hierarchy is the sⁱ allele, which results in a white underside and white neck collar that may or may not be accompanied by white face markings, a pattern commonly referred to as

“Irish spotting”; the third allele in this dominance hierarchy series is the s^p allele, which creates a random distribution of white fur referred to as “piebald spotting”; and the final allele in the series is the s^w allele which is recessive to the three other alleles and dogs carrying two s^w alleles are almost entirely white, which is also referred to as “extreme white” (Figure 7)[9, 10].

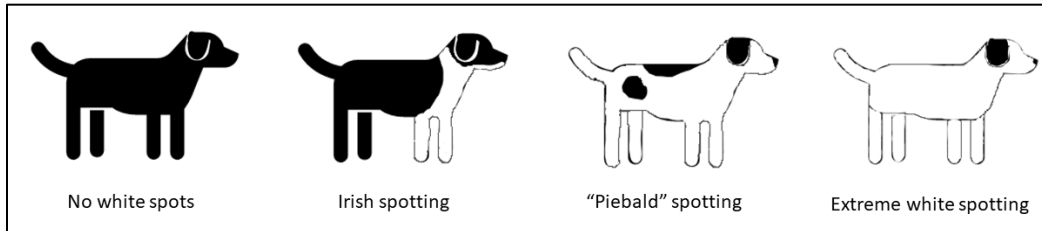
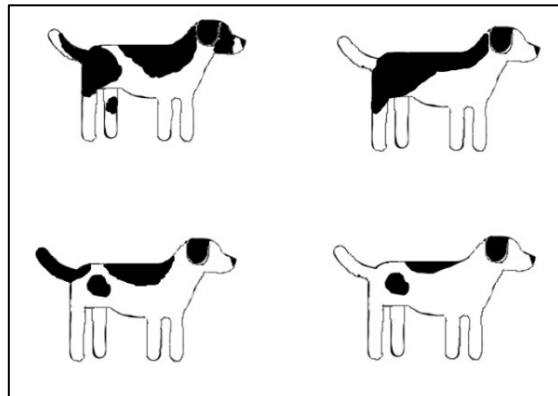

Figure 7: Different white spotting phenotypes determined by the S-locus alleles

iv. Variable Expressivity

Variable expressivity refers to a range of phenotypes resulting from the same genotype. This means that all individuals carrying a particular genotype will display the associated phenotype, but the degree or extent to which the phenotype is displayed can vary.



An example of variable expressivity is the piebald spotting of dogs (Figure 8), where the actual amount of white spotting seen may vary considerably among dogs with the same genotype [11].

Figure 8: The $s^{ps}ps$ genotype producing piebald spotting exhibits variable expressivity as shown in these four dogs.

v. Polygenic and Complex Inheritance

In contrast with Mendelian traits, which are governed by a single gene (*i.e.*, monogenic), complex traits are those governed by more than one gene (*i.e.*, polygenic) and may also be influenced by the environment (*i.e.*, multifactorial) [12, 13]. In dogs, eye color is considered a polygenic trait, whereas body size is a multifactorial trait [14], governed by multiple genes and also influenced by environmental factors such as exercise and nutrition. Hip dysplasia is another example of a multifactorial trait in dogs [15].

vi. Gene Interactions

In some cases, the phenotype observed for a particular trait can be affected by the alleles present at other genes. The interaction between genes, where one gene influences the phenotype expression of another gene, is termed “epistasis.”

Although the term epistasis generally refers to the interaction between genes [16], it is often used to describe a more extreme case of gene interaction where one gene’s phenotype is completely masked or hidden by another independently inherited gene [17]. Epistasis can also be dominant or recessive. In dominant epistasis, the presence of a single dominant allele at one gene is sufficient to completely mask the phenotype of another gene, whereas in recessive epistasis two recessive alleles at one gene are necessary to mask the phenotype of another gene. An example of recessive epistasis in dogs is the yellow coat color seen

in Labrador Retrievers. Yellow Labradors are yellow because they have two recessive alleles at the E-locus, which we now know to be the melanocyte-stimulating hormone receptor (*MC1R*) gene, and this homozygous recessive genotype (ee) overrides the genotype found at the B-locus. So, for example, a Labrador that would otherwise be black because it has a homozygous dominant genotype at the B-locus (BB) will actually look yellow because its E-locus genotype (ee) overrides the B-locus. Because of this, it can be difficult to determine which alleles a yellow Labrador has at the B-locus.

The term “modifying gene” often refers to a less extreme situation where one gene will simply influence the phenotype of another gene, resulting in a variation of the expected phenotype. For example, dilute coat color in dogs is determined by a modifying gene called melanophilin (*MLPH*), also referred to as the D-locus. At least three different mutations within this gene, having a recessive inheritance pattern, are associated with dilute coat colors in multiple dog breeds [18-20]. The presence of any two mutated alleles at the D-locus results in a lighter variation of the coat color, so that dogs with a black coat color, as determined by the B-locus, will then display a dilute black coat color (blue) and dogs with a brown coat color will display a dilute brown color often referred to as lilac, fawn or Isabella coat color, as seen in the Doberman Pinscher and Dachshund. If you are interested in coat colors, please refer to this [paper](#).

vii. Pleiotropy

Pleiotropy refers to a situation where a single gene affects two or more seemingly unrelated traits. For example, some coat patterns (*e.g.*, piebald white spotting) are associated with congenital [hereditary deafness, blue eyes, and eye defects](#) [21]. This is because the mutations that cause the change in the coat pattern also impacts the cells that are important for ear and eye development. Another example of pleiotropy is seen in Rhodesian Ridgebacks, where the gene that governs the characteristic ridge of backward-growing hair that runs across the dog’s back can also predispose for a neural tube defect called dermoid sinus [22].

viii. Mitochondrial Inheritance

In addition to the genetic material found in a cell’s nucleus, which is composed of DNA inherited from the dog’s mother and father (*i.e.*, the nuclear genome), a separate and much smaller genome is also present in the mitochondria of mammalian cells. Mitochondria are organelles within a cell, distinct from the nucleus, that generate the energy needed for a cell to function. The mitochondrial genome differs from the nuclear genome in that it is exclusively inherited from the mother, and this mode of inheritance is thus referred to as maternal inheritance. Although mitochondrial disorders only come from the mother, they can equally affect male and female puppies because they are not sex-linked (*i.e.*, not located on a sex chromosome) [11]. Two mitochondrial disorders have been described to date in dogs: canine spongiform leukoencephalomyelopathy in Australian cattle dogs and Shetland sheepdogs [23], and sensory ataxic neuropathy in Golden Retrievers [24].

ix. Codominance

Similar to incomplete dominance, codominance also occurs in the absence of a recessive/dominant relationship between the different alleles of a particular gene. However, unlike incomplete dominance, in codominance, the products of both alleles in a heterozygous individual are fully expressed and observed at the same time. Codominance has been described in humans [25], but a clear example has not yet been identified in the dog.

III. Genetic Selection and Populations

Genetic variation refers to the differences at the genetic level observed amongst individuals of a same species. The diversity of alleles, rearrangement of genetic material and parental contribution of different alleles to their offspring leads to genetically unique individuals, providing the flexibility in traits that allows for some individuals of a species to adapt, thrive, and survive any changes to their environment. Certain genetic combinations that enable an animal to survive and reproduce in a changing natural environment will be favored under natural selection. For example, imagine that dogs with certain genetic combinations are more resistant to a deadly infectious disease and, should that disease spread through the population, individuals resistant to the infection will survive and pass on those resistance alleles to the next generation. The result is a change in the frequency of alleles in the population where resistance alleles will be more common in the surviving population compared to the original population. Natural selection is based on the fitness or adaptability of an animal to the environment and is very important in wild animals.

Genetic selection can also occur artificially, when people purposefully select individuals with specific, desirable traits. Artificial selection, or breeder selection, reflects a breeder's preference for particular traits. As an example, in the formation of dog breeds characterized by short legs, breeders hundreds of years ago found dogs closer to the ground better suited for hunting some prey and, therefore, selected mates having short legs to produce short-legged puppies. With more dogs bred for functionality and/or companionship, artificial selection now plays a larger role than natural selection [26]. Artificial selection, while enhancing certain traits, does not necessarily increase the overall fitness of a species.

In extreme situations, both natural and artificial selection can result in a drastic reduction in the number of individuals that will breed and contribute to the next generation, a situation referred to as population bottleneck. When few individuals contribute to future generations, genetic diversity of the resulting population is reduced [27], leading to individuals with a more homogenous genetic background and reduced gene pool (Figure 9).

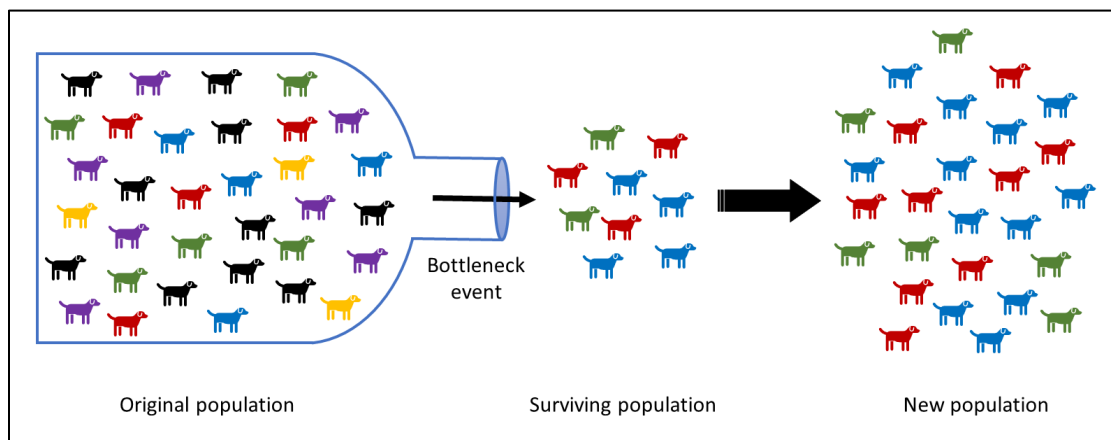

Figure 9: Illustration of how a bottleneck event can affect the genetic diversity (gene pool) of a population. The different colors used symbolize dogs with the different alleles of a same gene. Three of the six alleles of that gene conferred survival advantage, so that individuals with the green, red and blue allele survived the bottleneck event. The new population now reflects a reduced genetic diversity compared to the original population.

All dogs have undergone two major population bottlenecks, the first occurred when dogs were domesticated from wolves and the second, more recently, when modern dog breeds were created [27]. Note that natural selection can also occur within artificially selected populations. For example, in the early 1900's, a subpopulation of Nova Scotia Duck Tolling Retrievers (NSDTRs) survived two distemper outbreaks [28], resulting in the breed undergoing an additional population bottleneck caused by natural selection; the small number of distemper survivors gave rise to the modern NSDTR population. It should also be noted that, following a population bottleneck, any disease mutations present in the surviving individuals will also become more prominent in future generations. The bottleneck suffered by NSDTRs in the early 1900's is thought to be associated with the high prevalence of disease in the breed.

The genetic diversity of a population can also be affected by chance, that is, when only some individuals within the population reproduce successfully. That means, the alleles present in the limited number of dogs used to produce the next generation will increase in frequency in the resulting population, even those alleles not being actively selected. This is called genetic drift and is extremely important in small populations, such as dog breeds, where often only a limited number of dogs are selected for breeding. For example, the overuse of a particular stud dog can dramatically change the frequency of all alleles in a small population, and then subsequent generations will have a predominance of his alleles, both the good and the bad. Popular sires have been shown to spread deleterious alleles much more profoundly throughout a population than other breeding practices, such as inbreeding [29]. An outcome of genetic drift is reduced genetic variability in the population. The following [link](#) provides an overview of the effect of genetic drift, founder individuals and population bottlenecks.

As a consequence of artificial or natural selection, alleles for other traits may also be inadvertently selected for due to genetic linkage; this circumstance underlies the concept of a selective sweep. Selective sweep refers to different traits being inherited together because of the physical proximity of genes governing them such that selective pressure for one trait will unintentionally cause selection for the linked trait. In other words, when traits are being actively selected for, other traits will “piggyback” or “hitchhike” along merely because of the physical adjacency of genes underlying those traits on a chromosome. For example, genes that govern breed-specific or desirable temperament traits may be adjacent to a different gene that controls an undesirable trait. In this case, if a dog was used for breeding because of its desirable traits, yet it has “bad alleles” for an adjacent linked gene, the “bad alleles” will piggyback and be passed on to the next generations because of linkage. The closer the genes are on a chromosome, the less likely that recombination will take place in between them disrupting their genetic linkage. What this means is that when genes are tightly linked, such as the hypothetical example above, when you select for a desirable trait you are also unintentionally selecting for the undesirable one.

An interesting phenomenon that also affects the frequency of alleles in a population is called balancing selection. In natural selection, one allele is often favored over another because it provides better adaptation and survival of individuals in that environment. With time, the favored allele will increase in frequency and the frequency of the other allele will be greatly reduced or eliminated. Balancing selection, however, works to maintain the genetic variation within a population instead of favoring one allele over another. In balancing selection, the benefits of maintaining multiple alleles offset the potentially damaging effects of any individual allele. For [example](#), the mutation that causes sickle cell anemia in humans affects an individual's ability to thrive. Yet, the mutation seems to be maintained in the population because it can

benefit individuals in areas where malaria is endemic. Humans who have one sickle cell disease allele and one normal allele are more resistant to malaria infection than those with two normal alleles. Examples of balancing selection have also been described in dogs. For example, a mutation in the myostatin gene causes double-muscling in Whippets; dogs with two mutant alleles are over-muscled, described as “bully” Whippets, and have episodes of muscle cramping, whereas dogs that have one mutant and one normal (wildtype) allele are more muscular than those with two normal alleles and are able to race faster [30]. The mutated allele provides an advantage in the heterozygous state and is, therefore, maintained in the population. Another example was described in the Belgian Malinois, where dogs heterozygous at the Cadherin 2 (*CDH2*) gene, having one mutated and one normal (wildtype) allele, display an intermediate level of circling behavior that allows them to have better work performance in confined spaces, whereas dogs with two mutated alleles exhibit excessive circling behavior that is characteristic of obsessive compulsive disorder [31].

IV. Dog Breeds as Populations

There are over 350 dog breeds in the world [11, 32], 193 of which are officially recognized by the American Kennel Club [33]. A breed consists of individuals that conform to a particular set of physical descriptors that include size, coat color, fur length, and skull shape, among others. When mated, individuals within a breed will always produce offspring with the same physical traits that characterize that breed [34]. Centuries of selective breeding to produce dogs with specific characteristics has reduced genetic diversity of individuals within a breed, yet substantial variation remained across breeds, so that each individual breed consists of a genetically distinct population [11, 35].

As mentioned [above](#), different alleles can cause different phenotypes of a particular trait. During breed creation, a small number of founder dogs with desirable traits and features was selected for breeding with the purpose of homogenizing the resulting population. This allowed breeders to eliminate alleles responsible for phenotypes that were undesirable. Selective breeding within a small starting population inevitably leads to the mating of closely related individuals, also known as inbreeding. The positive consequence of inbreeding is the concentration of desirable traits and their corresponding alleles within the population, resulting in more homogenous litters where all puppies exhibit those desirable traits breeders sought to emphasize. This ability to replicate breed-defining traits down through the generations is due to the reduction in genetic diversity and fixation of alleles causing breed-defining traits (that is, homozygosity at breed-important genes). However, another consequence of inbreeding is the increase of observed genetic disorders.

Most genetic disorders in dogs are believed to be controlled by recessive alleles, and by increasing the frequency of desirable alleles, which leads to homozygosity of breed-defining genes, inbreeding also inadvertently increases the frequency and homozygosity of recessive disease alleles present in the dogs selected for breeding. Note that inbreeding does not introduce disease mutations, but rather reveals their presence in the population due to increased frequency of any disease alleles. Despite selecting mating pairs that are not as closely related as seen with inbreeding, line breeding employed to concentrate and maintain desirable breed traits [29, 36], along with the preferential and widespread use of specific individuals within a breed (i.e. popular sire effect), also contributes to reducing genetic diversity within individual dog breeds [29].

When a breed is fixed for certain alleles, meaning all dogs of that breed only have one type of allele, and that allele confers an advantage, then fixation is beneficial to the breed. However, when the allele that is fixed causes disease, then fixation becomes detrimental to breed health. Although deleterious recessive alleles are not intentionally selected for, they become more frequent in the population due to genetic drift and selective sweeps, as described in section IV. When deleterious alleles are fixed within a dog breed, selection for a healthy allele becomes impossible because no alternate alleles exist within the breed population. An example of this has been reported in Dalmatians: all Dalmatians are homozygous for a recessive allele that causes hyperuricosuria and hyperuricemia (HUU), predisposing them to bladder stones. Since Dalmatians lack diversity for that gene, breeders cannot selectively breed to reduce disease. In contrast, although that same recessive allele causing HUU has been identified in other breeds, those other breeds are not fixed for the recessive HUU allele and breeders can use genetic testing and selective breeding to avoid HUU [37]. [Note, since the discovery of the mutant HUU allele being fixed in Dalmatians, in 2011 the American Kennel Club (AKC) and Dalmatian Club of America [permitted](#) the careful incorporation of another breed to introduce a normal allele in the breed population].

When we think of a breed as a population, the physiological characteristics that define a breed should be considered. Certain phenotypes that are characteristic and/or definitive of a breed may also be associated with higher risk for particular disorders [38], especially if previous artificial breeder selection exaggerated those breed-specific features. For example, current efforts to address heat and exercise intolerance in brachycephalic breeds is in response to concerns of exaggerated selection for skull shape in [brachycephalic breeds](#). If there is sufficient genetic variability within a breed to purposely select away from the extreme characteristics that may predispose to disorders, breeders should do so.

When genetic tests are available to help select for improved health, those can be used provided the selection is applied gradually so as not to depopulate the breed, causing another population bottleneck. Dog breeders must be mindful of the “big picture” and how their choices will impact the population. When selecting mating pairs, one should not just think about the characteristics of their individual dogs and the puppies they hope to produce, but also consider making choices that can improve the breed as a whole for future generations. For example, when a dog is not used for breeding, none of its alleles for any of its genes will be passed on to the next generation, which may shrink the gene pool of available alleles for the future. Breeders must balance their desire for certain attributes with breed health concerns, all while avoiding decisions that could contribute to a loss of genetic diversity in the population (*i.e.*, a reduced gene pool).

V. Canine Genetic Tests

Breeders and owners want to maximize desirable traits and minimize traits that are undesirable or negatively impact a dog’s health. Hundreds of desirable traits and genetic disorders have been [compiled](#) and [curated](#) in the dog. Punnett squares can be used to predict the possible genotypes, and thereby phenotypes, of puppies from a particular breeding pair when dealing with single-gene traits. However, Punnett square predictions require knowledge of parental genotypes and determining the true genotype of every dog can be difficult, since those exhibiting dominant phenotypes may have a homozygous dominant or a heterozygous genotype. In these cases, it may not be possible to determine an individual’s true genotype

until it is bred enough times and the puppies evaluated, unless a genetic test exists to determine which alleles the dog possesses.

Another issue is seen with traits that are governed by the interaction of different genes, making it difficult, if not impossible, to accurately infer a dog's genotype solely based on their observable phenotype. Moreover, some traits, especially undesirable disease traits, are expressed later in life, long after a dog reaches the appropriate breeding age, making it difficult to select against these conditions. Genetic testing, offers the opportunity to accurately determine a dog's genotype at a very young age, before they are ever bred, allowing breeders to make important decisions regarding which dogs to breed to enhance desirable traits, and reduce undesirable ones.

Among the many canine genetic tests currently available, some are used in parentage verification (e.g., genetic identity), such as the [AKC DNA profile](#). Other tests are used to predict breed ancestry composition, detect alleles responsible for particular phenotypes, such as coat color, or indicate whether a dog is at risk for developing a particular trait, the latter often associated with undesirable disease traits. Genetic tests can also identify the carrier status of an individual dog; carrier status is a term often used to describe individuals with a heterozygous genotype that carry an allele for a recessive phenotype. That is, dogs who do not exhibit a specific phenotype or disease but, since it has a heterozygous genotype, could pass on a recessive allele to their puppies [39].

a. Direct and Indirect Tests

When the actual DNA sequence responsible for a trait has been identified, a direct, or mutation-based, genetic test can be developed. Genetic tests that use direct analysis identify the presence of the exact variation in the DNA that causes the phenotype. Direct tests are highly accurate because they determine whether or not a dog's DNA contains the causal mutation.

In some cases, however, the actual gene or precise mutation has not been identified. There may be a region of the dog's genome that clearly contains the causal variation, but amongst the many variations, the exact one is not yet known. As segments of DNA physically close to one another tend to be inherited together as a block, or "linked", indirect (or linkage-based) DNA tests rely on genetic variants (markers) linked with a phenotype to predict the dog's alleles at the causal variant [40]. An example of a linkage-based test is the one developed for [cerebellar ataxia in the Italian Spinone](#). Indirect tests may not be 100% accurate because recombination during [gamete production](#) can separate linked markers from the causal variant. In this way, linkage-based tests are less reliable than direct mutation-based tests.

With few exceptions, genetic tests currently available for dogs are based on the analysis of a dog's DNA. An owner will either take a swab sample of cheek cells from inside the dog's mouth with a tiny brush, collect saliva on a special sponge, or submit a blood sample for testing; some testing providers even accept dew claws. Regardless of the sample submitted, the DNA is purified from the cells and then used in the testing scheme.

b. Single versus Multipanel Tests

Both direct and indirect tests can be performed either as a single test, where we look for one segment of DNA, or in combined tests, where multiple segments of DNA are being looked at simultaneously. These are also referred to as singleplex or multiplex testing, respectively. That is the essential key piece for understanding how the tests are done. However, for those interested in more specifics and some of the challenges of DNA testing, please read on.

Singleplex tests are most often done through a process called polymerase chain reaction (PCR). In PCR, a short guiding sequence of DNA, called a primer, specifically targets the chromosomal region being evaluated and is used to create thousands of copies of the target DNA sequence. This amplification of the DNA is necessary so the DNA sequence present in an individual dog can be accurately determined. Each single gene test requires its own reagents and reaction time to analyze, as well as a separate sample of DNA [41].

Multiplex testing also uses PCR but bundles the reactions. Multiplex or panel testing can be more cost-effective and time-efficient, allowing for more information to be obtained with fewer reagents and a single DNA sample. However, multiplex panels can be harder to develop and validate because all the components necessary for each individual test must work well together in a combined test. The primers for each chromosomal sequence targeted must be able to work efficiently and not interfere with each other. Errors in primer design, whereupon an incorrect chromosomal region is targeted or where more than one region of the DNA is being unintentionally amplified, can result in erroneous results. Moreover, some target chromosomal sequences may be easier to amplify than others, such that reagents could get preferentially used up for one target sequence at the expense of amplifying the other targets, leading to incomplete or inaccurate results [42].

An alternative to PCR multiplexing that simplifies the process of panel testing is the microarray genotyping technology offered by companies that specialize in technology specific for DNA sequence determination. Microarray genotyping technology allows for the simultaneous testing of hundreds of thousands of single nucleotide variations, producing high-quality and accurate SNP detection [43]. Commercial companies that offer testing through microarray panels assess hundreds of genetic mutations that have been associated with traits, and company advertisements often highlight the number of different tests run at one time. The mutations that are being tested may have been rigorously validated or they may have been incorporated into the testing scheme based upon small and/or recently published studies from the scientific literature. Similar to what we see in humans, with 23&me and other direct-to-consumer genetic testing, large-scale panel testing can be very cost-effective for dog owners and breeders, yielding information on multiple traits, and may contribute to new genetic variants being discovered. Furthermore, just as being done for humans, some dog genetic testing companies also offer to identify relatives of the tested dog.

VI. Interpretation of DNA Test Results

The dog owner who requests a DNA test should understand what the testing service actually provides, how the test results will be shared, and how to interpret them. The DNA test result provided by most testing laboratories usually includes a dog's genotype for the investigated gene(s) and/or trait(s), an interpretation of that genotype in terms of whether the dog is expected to exhibit a particular phenotype,

and the ability that dog has to transmit the particular characteristic to its puppies. In most cases, the terminology used in test results is straightforward and easy to understand. For phenotypic traits such as coat color, the DNA test results are usually provided with the letter abbreviation of the allele and a description of the color (*e.g.*, B/B genotype means black fur pigment and only the B allele can be transmitted to puppies). For disease traits, the test results may also give a letter abbreviation of “N” for normal (or a lower case n, dependent upon the test provider) and then a letter abbreviation for the disease allele (*e.g.*, N/HU for a dog that is heterozygous and carries one normal and one hyperuricosuria and hyperuricemia HUU allele discussed previously). The letter abbreviation used for alleles of the same gene is not always consistent across different test providers, and the inconsistent terminology can sometimes cause confusion. Test reports may also include information on the actual change detected in the DNA by referring to insertions (INS) or deletions (DEL).

For coat color test results, another complication comes from genes that affect the phenotypes of different traits. Again, using fur color as an example, black fur in dogs can be caused by more than one gene. A dominant allele at the beta-defensin 103 (*CBD103*) gene on canine chromosome 16, also called the K-locus, can cause a dog’s fur to be black. This gene is sometimes called “dominant black” because the K gene is [epistatic](#) over another gene called agouti. The alleles at the agouti gene control banding patterns in the fur, for example the sable or black and tan coloration. At the K-locus, the K^B allele (sometimes denoted KB) is completely dominant. If the dog has even one K^B allele, the coat color will be black, masking the effects of whatever alleles the agouti locus has. If, on the other hand, it is homozygous for the k^Y recessive allele, the coat pattern regulated by the agouti locus will be observed. The test result will provide the information on the K-locus and the owner needs to understand how that result affects the other genes that regulate coat color. Dr. Sheila Schmutz, an Emeritus Professor from the University of Saskatchewan, has a [website](#) that details the genes that contribute to a dog’s coat color and how they interact.

Genetic testing for health conditions is becoming widely available but can be more difficult to understand. “Clear”, “carrier” and “affected” are commonly used in genetic test results for autosomal recessive disease phenotypes. A “clear” result indicates that the dog possesses two dominant alleles for the tested gene, meaning it will exhibit the dominant normal phenotype. A dog with this genotype can only pass on a dominant, normal allele to its puppies, thus none of its puppies will be affected by the disease. A “carrier” result indicates that the dog is heterozygous, having one dominant and one recessive allele. While this dog will exhibit the dominant normal phenotype, it will pass on a recessive disease allele to approximately 50% of its puppies. Finally, an “affected” result indicates the dog is homozygous for the recessive disease allele, having two recessive alleles, and will be affected by the disease. An “affected” dog will also pass a recessive allele to each of its puppies. Disorders that have incomplete penetrance, meaning that only a portion of the individuals having the disease genotype will develop clinical signs, are defined with these same terms. In this case, however, not all dogs defined as “affected” will develop the disease but, if bred, they will certainly transmit a disease allele to their puppies.

Test results for an autosomal dominant phenotype may be described as “clear”, “heterozygous affected” or “homozygous affected”. For dominant disease phenotypes, dogs with a “clear” result are homozygous recessive and have no dominant disease alleles; they are not able to pass on a disease allele to their puppies. Dogs with a “heterozygous affected” result will exhibit the dominant disease phenotype, have one dominant disease allele and one recessive normal allele. This dog will pass on the dominant allele to

about 50% of its puppies; the other 50% will receive the recessive allele. Dogs with a “homozygous affected” result have two dominant disease alleles, exhibit the dominant disease phenotype, and can only pass on dominant disease alleles to its puppies and every one of its puppies will exhibit the dominant disease phenotype [44]. The term “negative” may be used in place of “clear” to describe a dog that does not possess any alleles associated with the investigated phenotype.

For both recessive and dominant Mendelian tests, “clear by parentage” is a designation that can be applied to puppies if both parents have been genetically tested and definitively shown to be free from the disease mutation and the puppies’ parentage has been verified. For example, if both parents of a litter test “clear” for a recessive disease, then all of their progeny must be clear, and it is not necessary to conduct a genetic test on the puppies to show this.

Another term often causing concern and confusion among dog owners and breeders is “risk”. A dog’s DNA test result may indicate it is “at risk” for developing a disorder. Specifically, the presence of certain alleles are associated with greater probability of developing a disorder [45], but the presence of these alleles cannot definitively determine whether, or when, a dog will actually develop the disorder. Some dogs that test positive for the presence of risk alleles will never develop any clinical signs of disease. For example, the risk designation can be given for a single gene that has incomplete penetrance (*e.g.*, necrotizing meningoencephalitis (NME), also known as Pug Dog Encephalitis (PDE)). Note that multifactorial diseases involve multiple genes and non-genetic factors, and so a genetic test can only indicate a level of risk for disease development even when multiple genes are being assessed. An example of this, and a first of its kind for a dog breed, is the risk assessment developed for dermatomyositis (DMS) in the Shetland Shepherd and Collie breeds [46]. The research team developed a 3-part DNA test that can help breeders determine the risk an individual Sheltie or Collie has for developing DMS. Based upon the alleles present at three loci a dog can be classified as low, moderate, or high risk. The test determines genetic variants at three different locations in the genome. For a detailed explanation of the disease and how the test results can be applied to individual dogs or dog breeding, refer to the American Shetland Sheepdog Association [website](#) and Dr. Leigh Anne Clark’s [talk](#) for the Collie Health Foundation’s Educational Series. For more complex examples, refer to [this video](#) for an illustration of risk testing in humans.

The important take away from the complex risk scenario is that genetic risk tests are not diagnostic tests and only reflect the risk of the individual dog that was tested. Moreover, even if a dog had a set of high-risk alleles, depending on the genetic makeup of the dog it is bred to, all of its puppies could have low risk genotypes. This is a great example of the need to consider all the attributes of a dog when deciding whether to breed it. If a dog has a high risk genotype for a disease but has many desirable features it could pass on to its puppies, a breeder may still consider breeding the dog as long as they could find a mate that would allow the generation of puppies with low risk genotypes for the disease.

VII. Diversity Testing

Knowing that genetic diversity is essential for the fitness and survival of a species [47, 48], dog breeders have not only been concerned about breeding for desirable breed characteristics and against genetic diseases, but also toward maintaining genetic diversity and a large gene pool for their breeds. Pedigree analysis and calculating the level of inbreeding is frequently used to evaluate genetic diversity in a

single dog or a breed. The inbreeding calculation is dependent upon the depth of the pedigree being assessed, that is, the number of generations being incorporated into the calculation. For breeds derived from few founding dogs, if one looks far enough back, all dogs in that breed will be substantially related.

With testing advances, another application of genetic testing in dogs is to look at the actual genetic diversity of a dog, rather than just relying upon calculating the level of inbreeding. Diversity tests often use random variations in DNA sequences that are spread across all the chromosome of the canine genome to assess the genetic diversity of a dog and/or dog breed. The variations targeted may be single nucleotides (SNPs) or segments of repetitive DNA sequences known as short tandem repeat (abbreviated STR) or microsatellite markers. The latter are highly variable between individuals and are commonly used in identity and parentage testing as well as in forensic science [49]. The SNPs or STRs used in these tests do not provide information on gene function but rather reflect natural variability in the genomic DNA sequence of an individual. Commercial testing companies may provide an overall diversity statistic for a given dog. These diversity values are based upon each company's database and proprietary calculations that might include overall homozygosity in the markers looked at and/or variability within particular genes (for example, those involved in immune function). Additionally, stretches of DNA in the genome that are homozygous (termed runs of homozygosity) may also be incorporated into the calculations because those reflect sections of DNA inherited in a block from common ancestors, and the length of the DNA stretch provides information on the level of inbreeding. Specifically, the longer and more numerous the stretches of homozygosity in a genome, the more inbred.

When the changes in the DNA, that is the genetic variants, are genetically linked and inherited together as a block, the combination is called a haplotype. Haplotypes can be composed of genetic variants across any region of a chromosome, within a particular gene or across several genes. In fact, some genetic tests use haplotypes (that is, a set of variants) within a gene to determine which allele a dog has for that particular gene. Haplotypes will be shared by populations that have descended from common ancestors, and since haplotypes reflect segments of DNA that are inherited together as a block, they can also be used to determine the ancestral origin of a dog. For example, breed-specific haplotypes can be used to determine which dog breeds have contributed to a mixed-breed dog's genetic makeup. Although many regions throughout the dog genome can be targeted, special attention has been given to the dog major histocompatibility complex (MHC) genes, also called dog leukocyte antigen (DLA) genes, more specifically DLA class II genes.

Variability and diversity in the MHC are paramount to pathogen resistance. The MHC complex contains the most diverse genes in vertebrates and thus are considered to reflect overall genomic diversity in a population. The MHC/DLA genes encode proteins that are essential for the proper functioning of the immune system, and genetic diversity within these genes is generally associated with disease resistance and increased fitness [50]. The MHC genes are extremely variable and many different alleles of each gene exist across individuals of a same species. Large stable populations in the wild tend to exhibit high variability across the MHC genes, and low MHC diversity tends to be correlated with a loss in genome-wide diversity, as seen in wild cheetahs and northern elephant seals, both of which have suffered population bottlenecks [51]. Similarly, population bottlenecks that occurred during the creation of dog breeds have led to a reduction in the diversity of the MHC/DLA genes within individual breeds, a concern to many dog breeders. In assessing diversity of MHC/DLA genes, emphasis is given to the DLA class II genes in particular, which are located very

close to each other on a single chromosome (dog chromosome 12) and are therefore inherited together as a haplotype block. Over 200 DLA class II haplotypes have been identified across more than 150 dog breeds, yet most dog breeds exhibit four or five common haplotypes with frequency greater than 10%; the number of different DLA alleles in the gene pool of any individual dog breed ranges from three [46] to 21 [52]. Negative consequences of excessive inbreeding (i.e. inbreeding depression) and the loss of MHC variability through inbreeding are inextricably intertwined, yet the specifics of particular MHC variability and which are adaptive (that is, helpful to survival) are less clear. MHC diversity testing, along with overall genetic diversity testing, are tools that provide breeders with an idea of the overall genetic variability in their dogs. The test results can be considered in mate selections to maximize the differences in alleles although generally minimizing inbreeding practices could serve the same purpose [53].

VIII. Breed Specificity of Genetic Tests

Many genetic tests are breed-specific, meaning they are not universally relevant or applicable across all dogs and dog breeds. In some cases, tests for a disease or trait are limited to a single dog breed. For example, the Juvenile Addison's Disease (JADD) mutation is specific for Nova Scotia Duck Tolling retrievers [54, 55] and the mutation in the phosphodiesterase 6B (*PDE6B*) gene causing progressive retinal atrophy is specific for Irish and Red Setters [56]. In other cases, the same mutation is found to cause disease in multiple dog breeds and a genetic test will be informative for all the affected breeds. Examples of genetic tests that can be used in multiple dog breeds are the progressive rod-cone degeneration (*PRCD*) test, which determines a late-onset form of progressive retinal atrophy, and the multidrug resistance gene 1 (*MDR1*) test.

In some cases, mutations may be present in multiple dog breeds yet only cause disease in some of the breeds. A mutation in the RPGR interacting protein 1 (*RPGRIP1*) gene is associated with early-onset cone-rod dystrophy (*cord1*) in miniature long-haired dachshunds [57], yet the variant has also been found in other breeds that do not display the eye disease, so the significance of the variant in other breeds is unclear. Moreover, recent studies suggest that additional genes contribute to disease expression in the dachshunds [58].

Another example is degenerative myelopathy (DM), which is associated with a mutation in the *SOD1* gene. In several breeds, dogs homozygous for the mutation have an increased risk of DM, yet the mutation is widespread across all dogs [59]. The DM situation is further complicated by the fact that, although inherited as an autosomal recessive, it has incomplete penetrance. Therefore, even in breeds in which the testing is relevant, a dog homozygous for the mutation, while being at increased risk for DM, is not guaranteed to develop the disease. Thus, two copies of the *SOD1* mutation (DM/DM) confer increased risk for DM but not all DM/DM dogs across breeds will develop the disease. Furthermore, there is some indication that heterozygous dogs of particular breeds may also have increased risk.

The volume of information provided from general panel testing may be overwhelming and confusing. Panel tests look at the presence of variants for many, sometimes hundreds, of different traits. Yet, for mutations of breed-specific health disorders, testing in other breeds is unwarranted; that is, the results are not applicable to disease susceptibility in other breeds. Some breeds may be fixed for the normal alleles such that the test is irrelevant or have compensatory genetic mutations in other genes that counteract the effects of the mutation being tested [60]. Genetic disease research is often conducted within individual dog breeds

that have a high prevalence of the disorder and the identified mutations are rarely validated in multiple breeds. Therefore, when a disease mutation is found in a dog belonging to a different breed, or a dog of mixed-breed descent, interpreting those findings must be done with caution.

Given the distinct genetic background of individual breeds, meaning each dog breed has its own allele composition and allele frequency across the many genes, some genetic variants will behave differently in the different breeds. When genetic testing is validated for one dog breed, but then applied to multiple breeds, the result may not be a true positive or negative for the associated disease. Without research and validation to demonstrate clinical validity of each test within each individual dog breed, large scale panel testing reports may be informing dog owners and breeders of mutations/disorders that are not relevant to their dog since a specific genetic background may be necessary for that mutation to actually cause disease. Owners acting on that information may pursue treatments, preventive measures, and diagnostic tests that may be unnecessary and potentially harmful to the dog [61-63].

Alternatively, there may be multiple genetic causes for a disorder and the available genetic test may only test for one of the many possible mutations. For instance, there are many different progressive retinal atrophy syndromes in the dog with many casual mutations restricted to particular breeds, although some mutations are more widespread and affect many breeds [56]. This is an example of breed specificity, with different breeds having different gene mutations that cause the same type of disorder.

The AKC has a [listing of dog breeds](#) and in those descriptions you will find information on the history of the dog, what qualities define that breed, and importantly a link to the national parent club of that breed. The parent club's website typically lists the areas of health deemed important for the breed, including for disorders that have genetic tests available. Another resource for owners, or prospective owners, is the [Canine Health Information Center \(CHIC\) Program](#), where the parent breed club has defined what the minimal health testing should include for that breed. The AKC's breeders' resources can be found [here](#) and [here](#), the Canine Health Foundation breeders' resources can be found [here](#), and health specific resources provided by the Canine Health Foundation can be found [here](#).

IX. Applications of Genetic Tests

Genetic tests are commonly used by pet owners and breeders to provide insight into the breed ancestry of mixed breeds, to verify parentage, to more accurately predict the presence of harmful mutations in their breeds, to better understand inherent genetic variability, and to provide valuable information for desirable traits, such as coat color or performance. On an individual dog level, genetic tests can be valuable in revealing susceptibility for negative reactions to drugs found in certain heartworm medication (*i.e.*, mutations in the *MDR1* gene) or providing insight into potential mature body size for a mixed breed. On a breed population level, incorporating genetic testing into breeding decisions can accelerate breeders' goals of improving desirable traits.

When receiving the results of genetic testing, the information needs to be reviewed carefully. A dog that shows the presence of a disease mutation does not necessarily mean the dog will show clinical signs during its life; owners should recognize that the genetic test results are not clinical diagnoses. The test may indicate the dog has a genetic predisposition (or risk) for a disease or trait and that clinical signs are to be expected. In the example above of the presence of the *MDR1* mutation, that knowledge will guide what drugs

are best avoided. However, risk for toxicity is recessive, so a dog carrying a single copy of the *MDR1* mutation would not be expected to experience any harmful effects. Lifestyle activities also influence whether a disorder is observed when the genetic mutation is present. As an illustration, Labrador Retrievers may have the mutation for Exercise Induced Collapse (EIC) but their activity level may never exceed that necessary for clinical signs to be observed [64]. The absence of signs in that situation, however, does not mean the genetic test was inaccurate, nor does it mean that the dog is free from the disorder and cannot pass on the mutation to its puppies. For other disorders, depending upon the age of onset, disease progression, and disease impacts on quality of life, in consultation with a veterinarian, an owner can create a roadmap for future treatment. Applying the results from genetic testing can be quite complicated.

For complex disorders, genetic tests may indicate the dog is at risk for the disorder. Risk and genetic predisposition do not guarantee outcome. Most complex disorders are controlled by many genes each having a small effect, and other factors, both genetic and environmental, influence how much of the risk is realized. Lifestyle management may have a profound role in whether a particular dog will exhibit disease symptoms. Furthermore, an owner and veterinarian must be cautious in applying genetic risk results. In some cases, clinical signs for different diseases overlap. If a dog's test results indicate it has a predisposition for a particular disease, and the clinical signs exhibited are consistent with that disease but those signs actually reflect a different disease in that dog, jumping to the wrong diagnosis may hinder appropriate treatment of the true underlying disease.

Prudently using genetic tests to select breeding stock can reduce Mendelian (*i.e.*, single gene) autosomal recessive disorders in a breed or population [64]. The key word is "prudently." If the mutant allele is not abundant in the population, and the disorder is harmful, the goal should be to avoid producing affected offspring or carriers and spreading the disease allele in the population. However, careful use of genetic testing to avoid further restricting genetic diversity and reducing the gene pool is paramount; this is especially true if the disease allele is fairly abundant in the breed. Genetic testing should be used to maintain the quality of a breed: by knowing which dogs have disease alleles and having a long-term goal, the frequency/abundance of the disease allele in the breed population can be **gradually** reduced. To not lose overall breed genetic diversity, a quality dog tested as a carrier could be bred to a dog tested clear (free from the mutation). In such a breeding, 50% of the puppies would be expected to be clear (Table 1) but will also have the genetic richness contributed by the carrier parent. The clear puppies from this breeding could be used in the next generation. In some cases, especially breeds with small populations and a limited gene pool, it may even be wise to breed an affected dog: choosing a clear dog as a mate would produce 100% carriers which can then be used as just described for the next generation. The objective is to avoid population bottlenecks and preserve as much genetic diversity as possible while reducing the frequency of the disease allele. When genetic diversity is preserved, the breeder is considering the genetic health of the population as well as the health of the individual. It needs to be emphasized that applying genetic selection to traits that are not relevant and/or extreme genetic selection to those that are relevant is very harmful to a breed.

Table 1: The chances of producing affected, carrier and clear puppies based on the genetic test status of both parents for Mendelian traits.

	Clear father	Carrier father	Affected father
Clear mother	All puppies are clear	50% chance puppy is clear 50% chance puppy is a carrier	All puppies are carriers
Carrier mother	50% chance puppy is clear 50% chance puppy is a carrier	25% chance puppy is clear 50% chance puppy is a carrier 25% chance puppy is affected	50% chance puppy is a carrier 50% chance puppy is affected
Affected mother	All puppies are carriers	50% chance puppy is a carrier 50% chance puppy is affected	All puppies are affected

There are many desirable traits and undesirable disorders in the dog population as a whole or within a specific breed, but few have genetic tests available. All animals carry deleterious mutations, many of them lethal when homozygous (e.g., it is estimated that any given human carries 1-2 lethal mutations in a heterozygous state [65]). Just because we have identified some of them does not mean we know all of them. Focusing mate selection solely on the results of existing tests to the exclusion of other traits important for a breed is not prudent. In other words, when selecting mates, the genetic test result must be weighed in the context of the whole dog and the breed in its entirety. Rarely do you breed for a single trait to the exclusion of all others. A preposterous example to illustrate this point is that no one breeds just for toenail size. Making breeding decisions solely on the results of a single genetic test would be similar. This is extremely important if the allele frequency of a disease is abundant within a breed—eliminating all dogs with that mutant allele, even carriers, from the breeding pool might decimate that breed, constrict genetic diversity, and result in the expansion of other disorders. Wholesale elimination of dogs from the breeding pool based upon a single test result can irreparably harm the entire breed by decreasing the gene pool or increasing the prevalence of other disease alleles that lack testing schemes [26, 66].

Implementing test results will be even more complex in the future, when more genetic tests will be multigenic and reflective of risk for a disorder in an individual dog. In these complex disorders, the presence of risk alleles is just that: they confer risk. It does not necessarily mean that the dog will exhibit that disorder nor does it mean that those risk alleles, or the risk for disease, will be passed on to the next generation if the risk is based upon a specific combination of alleles at multiple genes (see for example, [46]). In today’s peer-pressured, media-driven world that often calls for immediate and absolute action even if based on the misapplication or overextension of results, breeders and owners will need to use a thoughtful, reasoned approach in order to maintain the overall health of a breed. That includes researching the quality and clinical validity of the test itself, the laboratory offering the test, the advertising claims, the prevalence of the trait in the population, and the health impacts of a particular disorder. A paper describing the challenges and strategies related to breeding in the era of genetic testing can be found at this [link](#).

X. Genetic Test Providers and Oversight of Genetic Testing

a. Providers

Genetic testing for dogs has expanded considerably in the past decade, with hundreds of thousands of individuals already tested. There are commercial for-profit companies that offer multiplex panel testing that evaluate hundreds of traits simultaneously irrespective of breed being tested. There are commercial for-profit operations that offer more specialized subsets of bundled genetic tests focused on specific traits/disorders that address a specific breed's needs. There are research laboratories that offer very specific single trait testing as a service to breeders and owners. Finally, there are not-for-profit laboratories associated with research universities that offer a variety of single or bundled trait testing. In addition to tests for specific traits, some genetic test providers offer ancestry analysis and breed identification, parentage testing, and genetic diversity testing. In some cases, the results from large panel testing can also yield information on ancestry and diversity.

The number of worldwide laboratories offering tests is substantial. A testing provider that is for-profit may have different economic drivers than a not-for-profit provider and will often engage in compelling advertising to engage clients. The different testing provider models have both positive aspects and drawbacks. Pricing, service, genetic counseling, and information on results can vary greatly by testing provider. Importantly, the level of customer support and genetic counseling on the use of the results will also vary. We contacted customer service for several providers by phone and email while preparing this document and some were responsive to questions and requests for clarifications whereas others were not. Some providers offer in-person genetic counseling and others have clients rely upon their website documentation.

Dog owners should research what tests they actually want (more is not necessarily better), what type of support is desired, how they want their dog's data to be used by the testing provider, and how they will apply their dog's test results. For example, the research laboratory that discovered the mutation being tested for may be more familiar with the nuances of the test and may also use the test results to further expand their scientific understanding of the mutation. Moreover, some direct-to-consumer testing providers will also utilize test results in ongoing research projects, and some indicate that the owners will receive the full SNP data derived from the large panel testing, which then allows owners to share their dog's genetic data with researchers conducting important studies all over the world. Owners should also research the company offering the test and pay particular attention to the sections of "terms of use" or "terms of service," which describe what is included and what is excluded in the services offered. Language might include "help identify risk factors," "good faith estimate," and "not designed to diagnose, prevent, or treat any condition, diseases or state of health", which may be in contrast to the advertisements or report forms.

b. Testing Parameters

Efficacy and reliability of genetic testing relies upon the integrity of many steps in the process that begin with sample collection at the home or veterinary office and extend to sample shipping and handling prior to any analytical steps (such as the cleaning of mechanical tools that may cross contaminate), the actual analysis itself (impurities or contaminants in the PCR reagents or machinery, or the design of components for the analysis), and environmental contamination that may exist in the laboratory (*e.g.*, aerosols) [67, 68]. Test results from a testing provider need to be accurate and precise. Ideally, the results of a dog's sample sent to

multiple testing providers should be the same. Accuracy and reproducibility within a laboratory and across laboratories require standard reference materials and proficiency tests.

In human genetic diagnostics, the federal Food and Drug Administration (FDA) and the Centers for Medicare and Medicaid Services (CMS) have authority to regulate genetic tests. The regulation focuses on analytical validity (is the test accurate and precise), clinical validity (does the DNA change detected by the test reflect a true health risk) and clinical utility (is the knowledge revealed by the test clinically useful); clinical utility is directly dependent upon clinical validity. The CMS regulates laboratories providing human clinical genetic testing through the Clinical Laboratory Improvement Amendments (CLIA) certification process that assesses and verifies the analytical procedures used, staff proficiency, and may assess testing adequacy. Additionally, the American College of Medical Genetics and Genomics published standards and guidelines for clinical genetics laboratories [69].

c. Oversight

Oversight for any genetic testing is challenging because the field of genetics is rapidly evolving and there is rapid development of new tests. Oversight of direct-to-consumer genetic testing companies for humans is limited and the National Institute of Health (NIH) and the [FDA](#) warn consumers to do their homework and look for companies that are certified through the CLIA program. The same “buyer beware” situation exists for dog genetic testing companies and laboratories, except there is no oversight body for dog DNA testing nor any CLIA-type programs for either clinical or direct-to-consumer testing. Currently there is a lack of specific guidelines or performance measures, including control samples/standardization and regular validation. Without uniform oversight and quality control of testing entities, results may be in error or vary across labs, yet accuracy and quality assurance of test results is paramount for their proper use.

Efforts to rectify the gap in oversight of dog genetic tests include a few voluntary programs in which test providers can participate by agreeing to meet certain standards, and a recent publication that defined a set of procedures for dog DNA testing modelled on human standards [70]. The International Society for Animal Genetics is a professional society that offers members the opportunity to voluntarily participate in DNA testing comparisons. The comparisons are aimed at standardizing genetic test results, particularly parentage tests, across the globe. The [Harmonization of Genetic Testing for Dogs searchable database](#) lists dog genetic testing companies who have voluntarily agreed to meet certain standards and share information.

Oversight of testing and appropriateness of a given test for a given breed is important in a clinical setting and, even more so, in the direct marketing of DNA testing to dog owners. A healthy dog should be the goal of every dog lover, but media and social pressure to “do the right thing”, a situation capitalized by provider marketing campaigns, is driving the recent surge in DNA testing of dogs. Yet, without providing proper context to a test result, genetic testing could lead to many undesirable outcomes for any individual dog or a breed as a whole. It can be helpful for dog owners to look at what is recommended to consider in human direct-to-consumer DNA testing [71] and what reporting information is essential to help the consumers better understand the meaning of the results [72].

XI. Caution Regarding Test Interpretation

As with almost any service, there are caveats when it comes to interpreting the results of canine genetic health testing. Genetic testing, while important for mixed and purebred dogs, requires understanding. Importantly, interpreting those results in the context of the dog as a whole is essential. Some diseases may be treatable or have limited impact on a dog's quality of life whereas others may require aggressive intervention. Before important decisions about disease treatment or prevention are made, owners should seek advice from their veterinarian or a geneticist. Statistical probability and risk is **not** certainty. Making inappropriate decisions based upon inaccurate, incomplete, or misunderstood information from test results may not be in the dog's or the breed's best interest.

Mentioned earlier in this document, not all genetic tests are relevant for all dogs. Unfortunately, there is no single entity compiling whether a test is appropriate for a given breed. Nonetheless, the Canine Health Foundation, in conjunction with Dr. Kate Meurs of the Veterinary Genetics Laboratory at North Carolina State University College of Veterinary Medicine, offers an [online opportunity for genetic counseling](#) and there are efforts by the [International Partnership for Dogs](#) to provide information on breed relevance of the different tests.

Furthermore, much of the research is very recent and scientists are still discovering new information and refining previous discoveries. As an example of the latter, in linked tests where markers are associated with a trait, but are themselves not the causal mutations, depending upon how physically close those markers are to the actual (unidentified) mutation, recombination can dissociate that linkage and eliminate the predictive power of the test. Then when a test is converted from a linkage test to a specific mutation-based test, the results can change--it goes from an approximation (sometimes a very good approximation) to something accurate, and previous test determinations may be modified. Or researchers discover, when more dogs are studied, that the mutation they thought was causal is actually only a piece of a more complex genetic puzzle.

Another consideration is that most genetic tests arise from statistically associating a specific genetic sequence with a disorder or trait. However, correlation does not always mean causation. In an effort to give owners and breeders tools, sometimes a researcher's results are converted into tests before proper clinical and causal validation have occurred. Many of the genetic tests currently available to dog owners and breeders are based on small studies and lack validation across multiple dog breeds [61]. Definitively confirming that a given mutation causes a disease may require hundreds to thousands of dogs, resources, and in some cases, purposely producing the disorder (ideally in a mouse or other model species, because purposely producing a disease in a dog would be viewed as unethical by companion animal granting agencies and most breeders).

In rare cases, test results themselves may not always be accurate. Based on varying sensitivities or sample integrity, there is a chance that an individual could be given a false positive or false negative result. Furthermore, as mentioned above, some genetic tests will be refined when more dogs are tested for that trait. As more dogs are studied, and greater breed-specific genetic signatures are developed, the association between mutations, disease, and breed will improve. Although not a health test, this principle of different reference pools influencing the genetic signatures can be illustrated with the breed ancestry identification tests. Using a sample of convenience of various mixed breed dogs, cheek swabs were sent to different

companies offering breed identification DNA testing. Every company utilizes its own proprietary statistical algorithms and a comparative population as a basis to estimate the breed composition in a given dog submitted by an owner. In this random sample, for some dogs the estimation of contributing breeds was similar between the testing companies whereas for other dogs, the predictions were more variable ([summary table](#)). This was seen in the human DNA ancestry testing: each company that offers human DNA ancestry testing uses their in-house DNA databank to compare a new sample to—and the bigger the reference population databank the more robust the associations [73, 74].

Yet another consideration is that when an owner receives a panel test that shows their dog is negative for the myriad of mutations tested (whether relevant to the breed/dog or not), that gives a false sense of security on the health of the dog. It also ignores the possibility of other genetic mutations existing that could cause the same disease. A recent [2020 article in Business Insider](#) illustrates this in the following quote: *“Nellie showed up negative for everything. Being able to rule out these mutations also makes it easier for your chosen vet to determine what's wrong quickly and accurately if your dog becomes sick in the future...”* Knowing the absence of some disease-causing mutations is a start, but that does not necessarily mean that the dog will not develop that disease, as there could be yet unknown mutations causing the same disease. For example, 62% of NSDTR puppies with cleft palate have a mutation in a particular gene but the remaining puppies with cleft palate do not have that mutation [75]. A different, yet unidentified, mutation is likely also causing cleft palate in this breed. As another example, a negative result in a dog for one seizure disorder should not lead an owner to believe their dog cannot be afflicted with epilepsy. There are many different possible causes of [seizures and epilepsy in the dog](#), some of which are not even genetic. Seizures caused by certain toxins or medication can look very similar to those caused by heritable disease, a situation referred to as phenocopy. Even within the genetic realm, over 900 genes have been associated with epilepsy in humans, and different genes may similarly underlie epilepsy phenotypes in different individual dogs and dog breeds.

While it would be ideal for owners to review the primary literature underpinning a genetic test they wish to do on their dogs, they should be aware that scientific papers are often written using extensive scientific jargon and can be difficult to understand. Although many journals are asking authors to include a lay summary written in terms that an average interested reader can understand, it is not uncommon for authors to overextend their findings in the lay summary while being much more cautious of their findings in the scientific summary or throughout the actual paper. It is, thus, important to review the entire paper and not only rely on a lay summary. For those who would like to embrace the challenge, there are certain key pieces to look for when reading scientific papers to check whether a genetic test is relevant to your breed: what breed(s) were studied, how many dogs were studied, were both sexes looked at, where were the dogs from (note that there may be genetic differences between geographically distinct populations), were they able to replicate the findings in a different group of dogs, and how explanatory were the findings (did all dogs with the mutation develop disease)?

XII. Impact of Genetic Testing

When appropriately interpreted and applied, genetic testing allows dog owners to determine if their dog may develop a hereditary disease. This is particularly important for disorders that develop later in life,

and for which increased clinical surveillance and/or lifestyle or dietary modifications could improve a dog's quality of life. Genetic testing also allows breeders to more accurately predict whether a dog will pass on a disease allele to its puppies. Proper implementation of genetic tests for autosomal recessive diseases has reduced the prevalence of disease [64] and can be used to assist in the health of a breed as a whole [76]. The American Veterinary Medical Association in conjunction with the American Animal Hospital Association recommends diagnostic genetic testing in its "[canine preventive healthcare guidelines](#)", aligning with their policy of "...better educate the profession and breeders on identifying and minimizing inherited disorders in companion animal breeding programs." A [position paper](#) by the World Small Animal Veterinary Association outlines some general high level principles to be considered in implementing genetic testing.

Another potential impact is that direct-to-consumer testing providers can mine the data derived from owners purchasing DNA testing to discover new genetic variants. For example, a mutation responsible for blue eye color in Siberian Huskies was found using direct-to-consumer testing data [77]. Another example, is the cataloging of variants observed across mixed and purebred dogs [78] which may aid in clarifying why some diseases are breed specific despite the mutation being more widespread across breeds. Also, as mentioned above, the research laboratories that discovered the mutation gain more information when more dogs are studied.

XIII. Future Advances

Genetic testing in dogs will likely follow the steps of human genetic testing protocols. Over the past decade, single-gene tests have given room to multi-gene or panel testing. In humans, panel testing involves the testing of multiple genes associated with a common genetic disorder, such as breast cancer or diabetes. Similarly, panel testing in dogs will likely evolve to the testing of genes behind a specific disorder or breed-specific genetic test panels that will assess only breed-relevant disorders. As complex disorders are studied in dogs, and the genetic susceptibility markers are uncovered, genetic panel testing will also include determination of polygenic risk scores for specific conditions, meaning the amount of risk conferred by a group of genetic susceptibility variants underlying specific complex disorders, similar to what is done in humans. Application of statistical network analyses to quantify risk have already been proposed for use in genetic counseling for dogs [79].

Many canine studies have now shown that certain MHC/DLA genes confer risk to autoimmune disease, such as DMS, type 1 diabetes, symmetrical lupoid onychodystrophy, lymphocytic thyroiditis (hypothyroidism) and Addison's disease, among others [80-83]. Further studies into the MHC/DLA class II haplotypes may clarify their effect on health and disease such that they can be incorporated into some of the multi-gene panels and in selective breeding.

Broad-range SNP panels may still be used in the future, but with a different purpose. Specific multiplex panels may use targeted SNPs distributed through the entire genome with a focus on providing genomic estimated breeding values to assess the likelihood of a dog passing on particular complex traits to its puppies. However, this will require a great many dogs with comprehensive phenotyping across varied environments and across breeds to obtain the accuracy in prediction necessary before such tests can be deployed.

Further in the horizon, and similar to that envisioned for human medicine, personalized canine medicine based upon an individual's whole genome sequence will eventually become available for cases where initial panel testing was uninformative. Whole genome sequencing consists of a DNA sequencing technique that determines the order of nucleotides in an individual's entire genome. The challenge with this technique, as seen in humans, is that extensive variation in DNA sequence exists between individuals, most of which are found in regions of the genome that are not genes, and thus their effect or importance is difficult to determine. Another challenge is the increasing evidence that DNA sequence is not the only factor determining heritable traits. Epigenetics is the study of how factors outside the DNA sequence can interact with the DNA to switch genes on or off, and although some of these factors can be inherited, the actual DNA sequence is not changed, instead what is changed is how the DNA is used.

Many studies will still need to be conducted to characterize how genomic sequences influence the many attributes of the dog, and that needs to be done within the context of the environment, which includes diet, exercise, geography, water and air contaminants, the microbiome (an area under intense study), and any epigenetic signatures present. Before this comprehensive goal is achieved there will be continued discoveries of association between genes/loci and traits.

XIV. Closing Thoughts

Genetic testing is extremely valuable and must be used to improve the health of dogs. Concerned and responsible dog lovers want to do what is best for their beloved companions, but the desire to achieve immediate changes should not get in the way of careful interpretation and consideration of genetic test results. Overuse or misapplication of genetic testing may lead to reduced genetic diversity in a breed if the frequency of a disease allele is high in that breed and all carriers of the disease allele are removed from the breeding population. We do want to breed away from deleterious conditions but not too quickly to avoid other health disorders becoming more prominent especially those diseases that lack testing schemes [26, 66]. For the genetic tests emphasizing genetic diversity, that diversity must be considered in context of the dog's other attributes. All dogs carry disease alleles and with more tests that will become more apparent. The expansion in available testing will necessitate a much more comprehensive view of implementing a given genetic test both for health management of a given dog, the breed as a whole, and the dogs selected for mating.

Glossary

Affected An individual who exhibits a deleterious trait or disease.

Allele A version or form of a gene or locus (it can even be applied to genetic markers not associated with a gene).

Artificial selection The process by which humans identify desirable traits in animals or plants, and select breeding pairs that exhibit such traits so that they will be passed on to future generations.

Autosomal dominant The inheritance of a phenotypic trait governed by a gene located in one of the autosomes, where the presence of one dominant allele is sufficient for the phenotype to be displayed. Dogs

that have one or two of those alleles (*i.e.*, heterozygous or homozygous dominant, respectively) will display the dominant phenotype.

Autosomal recessive The inheritance of a phenotypic trait governed by a gene located in one of the autosomes, where the presence of two alleles is required for the phenotype to be displayed. A heterozygous dog has one copy of the recessive allele and is called a carrier.

Autosome Non-sex chromosome. Dogs have 38 pairs of autosomes whereas humans have 22 pairs.

Balancing selection When multiple alleles are maintained at higher than expected frequencies within a population due to conferred advantages in different environmental conditions. One typical reason for this is heterozygote advantage.

Bottleneck When the number of breeding individuals is greatly reduced for at least one generation. See also population bottleneck

Breed (noun) A group of domesticated animals that descended from common ancestors and are visibly similar to one another in most characteristics.

Breed (verb) When a male and a female of the same species are mated to produce offspring.

Carrier An individual who is heterozygous for a recessive allele and, therefore, does not exhibit the recessive phenotype but will pass on the recessive allele to about 50% of its puppies.

Causal mutation or variant The genetic change that causes a difference in phenotype.

Chromosome A structure made up of a long molecule of DNA. In dogs, chromosomes exist in pairs with one copy originating from each parent. Dogs have 39 pairs of chromosomes (38 are autosomes and 1 pair constitute the sex chromosomes).

Codominance Traits where both alleles of a heterozygous individual are fully expressed at the same time.

Complex inheritance Traits or disorders governed by multiple genes and influenced by environmental factors. Complex traits are also called multifactorial.

Cryptorchidism A condition in which one or both of the testes fail to descend from the abdomen to the scrotum.

Deleterious Causing harm or damage.

Deletion When nucleotides are mistakenly removed from the DNA sequence during DNA duplication. A DNA test result may refer to the presence of a deletion by using the abbreviation DEL.

Diploid A cell or organism that has two copies of each chromosome, one copy coming from each parent.

Diversity Genetic diversity refers to the variability of inherited characteristics within a species, or the number of different characteristics determined by the genetic make-up of a species.

DNA An abbreviation for deoxyribonucleic acid, the genetic information of an individual stored in the form of sequences of nucleotides that provide instructions for making up the traits of that individual

Dog leukocyte antigen (DLA) The canine equivalent of the major histocompatibility complex (MHC). See Major Histocompatibility Complex.

Domesticate The process of adapting an organism to survive and thrive in a human-controlled environment.

Dominant Alleles whose associated phenotypes are always expressed.

Epigenetic Refers to factors outside of the DNA sequence that interact with the DNA structure to switch genes on and off.

Epistasis The interaction between genes; often associated with more extreme cases where one gene's phenotype is completely overridden (masked or hidden) by another independently inherited gene.

Fertilization Process by which a female and a male gamete combine to give rise to a new individual.

Fitness The ability of an individual or a species to survive and successfully reproduce in their current environment.

Fixation A situation where only a single allele exists for a given gene within a population or dog breed

Gamete Male (sperm) or female (egg) reproductive cell containing only one copy of each chromosome; used in fertilization during sexual reproduction.

Gene A section of DNA within a chromosome that contains instructions for the production of a specific protein. Genes determine the development of individual traits.

Gene interaction Gene interaction is when the phenotype observed for a particular trait is affected by the alleles present at a separate gene.

Gene pool The entire complement of the different alleles existing within a population or species.

Genetic drift Changes in allele frequencies within a population due to random chance, dependent upon which animals get to reproduce and contribute to the next generation (versus artificial or natural selection).

Genetic marker A DNA sequence or single nucleotide with a known physical location on a chromosome that is associated with a particular phenotype.

Genome An individual's entire genetic material (i.e. DNA) that provides instructions for building and maintaining the organism.

Genotype The combination of the two alleles that an individual has for a specific gene or locus.

Haploid Cells with one copy of each chromosome.

Haplotype A group of genetic variants inherited together coming from one parent.

Heterozygote/heterozygous An individual with two different alleles at a gene or locus.

Heterozygote advantage Heterozygous genotypes that confer higher fitness than the corresponding homozygous genotypes.

Homozygote/homozygous An individual with two identical alleles at a gene or locus.

Inbreeding Breeding of closely related individuals resulting in increased homozygosity and reduced genetic diversity. Linebreeding is a form of inbreeding where the relatives are more distantly related.

Inbreeding depression Reduced biological fitness of a population due to the mating of related individuals and consequent reduction in genetic diversity.

Incomplete dominance Traits where a heterozygous individual will display a mixture (or blend) of the phenotypes determined by each of the alleles.

Incomplete penetrance Traits or disorders for which only a portion of the individuals having a particular genotype actually show the associated phenotype.

Inheritance The transmission of genetic material and associated characteristics from parents to their offspring.

Insertion When nucleotides are mistakenly added to the DNA sequence during DNA duplication. A DNA test result may refer to the presence of an insertion by using the abbreviation INS.

Linkage The close physical proximity of genes or other segments of DNA on a same chromosome; due to linkage, these genes tend to be inherited together.

Locus The location of a gene, segment of DNA or region of interest on a chromosome

Major histocompatibility complex (MHC) A group of highly variable genes important in proper immune system function. High variability in these genes is associated with increased ability to resist/fight infections. The dog equivalent is called Dog Leukocyte Antigen (DLA).

Mendelian inheritance The inheritance of traits governed by a single gene.

Merle A coat pattern observed in particular dog breeds that is characterized by random patches of solid fur color intertwined with light fur color creating a marble-like pattern.

Monogenic inheritance The inheritance of traits governed by a single gene.

Mitochondrial inheritance A trait governed by a gene located within the mitochondrial DNA. In mammals, mitochondrial DNA is inherited solely from the mother.

Mutation Any permanent changes to the DNA sequence of an individual, which constitutes genetic variation.

Natural selection Refers to the survival and reproduction of individuals that are better adapted to their natural environment.

Nucleotide The basic building block of a DNA molecule.

Obligate carrier A dog that has not been genetically tested but is known to carry the recessive allele for a Mendelian trait because it has an affected parent or has produced an affected puppy when mated with a healthy individual.

Offspring Descendant(s) of an organism.

Pedigree The recorded ancestry or lineage of an individual.

Penetrance The proportion of individuals having a particular genotype who actually exhibit the phenotype associated with that genotype.

Phenocopy A phenotype caused by environmental factors (*e.g.*, medication) that is similar to that resulting from a particular genotype.

Phenotype The physical, observable and/or measurable characteristic of a trait.

Piebald The presence of random patches of white fur.

Pleiotropy A single gene affecting two or more different traits.

Polygenic inheritance The inheritance of a trait governed by more than one gene.

Polygenic trait A physical characteristic or disorder governed by more than one gene.

Polymerase Chain Reaction (PCR) A molecular biology technique used to generate multiple copies of a specific segment of the DNA.

Popular sire A sire who is used extensively so that subsequent generations have a high proportion of his genetics.

Population bottleneck A drastic reduction in the number of individuals that contribute their genetic material to the next generation, resulting in reduced genetic diversity of the future population.

Primer A short piece of DNA sequence used in PCR that establishes the starting point for copying the DNA region of interest.

Probability A mathematical representation of how likely it is that an event, or a phenotype, will occur.

Protein An essential molecule of the body, making up tissues, enzymes, hormones and antibodies that underlie different traits. Proteins are encoded by genes.

Recessive An allele whose phenotype is hidden by a dominant allele of the same gene; the recessive phenotype is only expressed if there are two copies of the recessive allele.

Recombination The rearrangement of genetic material that takes place during the formation of gametes. Recombination is an important mechanism for creating genetic diversity within a species.

Risk allele An allele that has been associated with increased likelihood that an individual will present a particular genetic disorder.

Runs of homozygosity Stretches of contiguous DNA sequences that are homozygous for that entire section because an individual inherited the same sequence from both parents indicating an origin in a common ancestor; longer lengths of the contiguous homozygous sequence (i.e., runs) are associated with inbreeding.

Selective breeding The selection of specific mating pairs with the goal of enhancing and/or eliminating particular phenotypes or disorders from future generations. Also called artificial selection.

Selective sweep The process of different traits being inherited together because the genes governing them are in physical proximity on the chromosome (linked).

Sequence The ordered arrangement of nucleotides in the DNA; genes are defined by particular sequences that provide instructions for making proteins.

Sex chromosome The one pair of chromosomes that determines an individual's sex; dogs carrying two X chromosomes are females and those carrying one X and one Y chromosome are males.

Sex-linked A trait controlled by a gene located on a sex chromosome.

Sex-limited A trait that can only be observed in one of the sexes (male or female) even though the gene that governs that trait is present in both male and female individuals.

Single Nucleotide Polymorphism (SNP) A change or difference in a single nucleotide within the DNA sequence. Often used within the context of DNA variant.

Trait A characteristic or attribute of an organism that is determined by gene(s) and/or influenced by the environment

Variable expressivity The different appearances of a trait or disorder in individuals with the same genotype.

Variant A single nucleotide or sequence of nucleotides that differs from the genomic sequence used as reference.

X-linked A trait governed by a gene located on the X chromosome.

Zygote A cell resulting from the fertilization of the female gamete (i.e. egg) by a male gamete (i.e. sperm) and will develop into a fetus.

References

1. Cooper GM: **The Cell: A Molecular Approach**. In., 2nd edn. Sunderland, MA: Sinauer Associates; 2000.
2. Lindblad-Toh K, Wade CM, Mikkelsen TS, Karlsson EK, Jaffe DB, Kamal M, Clamp M, Chang JL, Kulbokas EJ, Zody MC *et al*: **Genome sequence, comparative analysis and haplotype structure of the domestic dog**. *Nature* 2005, **438**(7069):803-819.
3. Memon MA: **Common causes of male dog infertility**. *Theriogenology* 2007, **68**(3):322-328.
4. Zhao X, Onteru S, Saatchi M, Garrick D, Rothschild M: **A genome-wide association study for canine cryptorchidism in Siberian Huskies**. *Journal of Animal Breeding and Genetics* 2014, **131**(3):202-209.
5. Clark LA, Wahl JM, Rees CA, Murphy KE: **Retrotransposon insertion in *SILV* is responsible for merle patterning of the domestic dog**. *Proceedings of the National Academy of Sciences* 2006, **103**(5):1376-1381.
6. Case LP: **Chapter 5 - Genetics and Breeding Programs**. In: *The Dog: its Behavior, Nutrition, and Health*. 2nd edn. Iowa: Iowa State Press; 2005.
7. Frischknecht M, Niehof-Oellers H, Jagannathan V, Owczarek-Lipska M, Drögemüller C, Dietschi E, Dolf G, Tellhelm B, Lang J, Tiira K *et al*: **A *COL11A2* Mutation in Labrador Retrievers with Mild Disproportionate Dwarfism**. *PLoS ONE* 2013, **8**(3):e60149.

8. Becker D, Minor KM, Letko A, Ekenstedt KJ, Jagannathan V, Leeb T, Shelton GD, Mickelson JR, Drögemüller C: **A GJA9 frameshift variant is associated with polyneuropathy in Leonberger dogs.** *BMC Genomics* 2017, **18**(1):662.
9. Schmutz SM, Berryere TG, Dreger DL: **MITF and White Spotting in Dogs: A Population Study.** *Journal of Heredity* 2009, **100**(suppl_1):S66-S74.
10. Karlsson EK, Baranowska I, Wade CM, Salmon Hillbertz NHC, Zody MC, Anderson N, Biagi TM, Patterson N, Pielberg GR, Kulbokas EJ *et al*: **Efficient mapping of mendelian traits in dogs through genome-wide association.** *Nature Genetics* 2007, **39**(11):1321-1328.
11. Ostrander EA, Ruvinsky A: **The genetics of the Dog**: CABI; 2012.
12. **NIH-Talking Glossary of Genetic Terms** [<https://www.genome.gov/genetics-glossary>]
13. Singh A: **Complex Traits.** In: *Encyclopedia of Behavioral Medicine.* edn. Edited by Gellman MD, Turner JR. New York, NY: Springer New York; 2013: 478-479.
14. Hayward JJ, Castelhana MG, Oliveira KC, Corey E, Balkman C, Baxter TL, Casal ML, Center SA, Fang M, Garrison SJ *et al*: **Complex disease and phenotype mapping in the domestic dog.** *Nature Communications* 2016, **7**(1):10460.
15. Todhunter RJ, Mateescu R, Lust G, Burton-Wurster NI, Dykes NL, Bliss SP, Williams AJ, Vernier-Singer M, Corey E, Harjes C *et al*: **Quantitative trait loci for hip dysplasia in a crossbreed canine pedigree.** *Mammalian Genome* 2005, **16**(9):720-730.
16. Miko I: **Epistasis: Gene Interaction and Phenotype Effects.** *Nature Education* 2008, **1**(1).
17. Anthony JF Griffiths JHM, David T Suzuki, Richard C Lewontin, and William M Gelbart.: **Gene interaction and modified dihybrid ratios.** . In: *An Introduction to Genetic Analysis.* 7th edn. New York: W. H. Freeman; 2000.
18. Philipp U, Hamann H, Mecklenburg L, Nishino S, Mignot E, Günzel-Apel A-R, Schmutz SM, Leeb T: **Polymorphisms within the canine MLPH gene are associated with dilute coat color in dogs.** *BMC genetics* 2005, **6**:34-34.
19. Bauer A, Kehl A, Jagannathan V, Leeb T: **A novel MLPH variant in dogs with coat colour dilution.** *Anim Genet* 2018, **49**(1):94-97.
20. Grahn RA, grahn JC, Colangelo JR, Malvick J: **A novel MLPH mutation results in a third coat color dilution variant in dogs.** In: *10th International Conference on Canine and Feline Genetics and Genomics May 26-29 2019; Bern, Switzerland; 2019.*
21. Strain GM: **The Genetics of Deafness in Domestic Animals.** *Front Vet Sci* 2015, **2**:29-29.
22. Salmon Hillbertz NH, Isaksson M, Karlsson EK, Hellmén E, Pielberg GR, Savolainen P, Wade CM, von Euler H, Gustafson U, Hedhammar A *et al*: **Duplication of FGF3, FGF4, FGF19 and ORAOV1 causes hair ridge and predisposition to dermoid sinus in Ridgeback dogs.** *Nat Genet* 2007, **39**(11):1318-1320.
23. Li F-Y, Cuddon PA, Song J, Wood SL, Patterson JS, Shelton GD, Duncan ID: **Canine spongiform leukoencephalomyelopathy is associated with a missense mutation in cytochrome b.** *Neurobiology of Disease* 2006, **21**(1):35-42.
24. Baranowska I, Jäderlund KH, Nennesmo I, Holmqvist E, Heidrich N, Larsson N-G, Andersson G, Wagner EGH, Hedhammar A, Wibom R *et al*: **Sensory ataxic neuropathy in golden retriever dogs is caused by a deletion in the mitochondrial tRNATyr gene.** *PLoS genetics* 2009, **5**(5):e1000499-e1000499.
25. Miko I: **Genetic Dominance: Genotype-Phenotype Relationships.** In: *Nature Education.* vol. 1; 2008.
26. Farrell LL, Schoenebeck JJ, Wiener P, Clements DN, Summers KM: **The challenges of pedigree dog health: approaches to combating inherited disease.** *Canine genetics and epidemiology* 2015, **2**(1):3.
27. Karlsson EK, Lindblad-Toh K: **Leader of the pack: gene mapping in dogs and other model organisms.** *Nature Reviews Genetics* 2008, **9**(9):713-725.
28. **Duck-Tolling Retrievers Yield Genetic Clues to Autoimmune Disease** [<http://www.bioquicknews.com/node/242>]

29. Leroy G, Baumung R: **Mating practices and the dissemination of genetic disorders in domestic animals, based on the example of dog breeding.** *Animal Genetics* 2011, **42**(1):66-74.
30. Mosher DS, Quignon P, Bustamante CD, Sutter NB, Mellersh CS, Parker HG, Ostrander EA: **A Mutation in the Myostatin Gene Increases Muscle Mass and Enhances Racing Performance in Heterozygote Dogs.** *PLoS genetics* 2007, **3**(5):e79.
31. Cao X, Irwin DM, Liu Y-H, Cheng L-G, Wang L, Wang G-D, Zhang Y-P: **Balancing Selection on CDH2 May Be Related to the Behavioral Features of the Belgian Malinois.** *PLOS ONE* 2014, **9**(10):e110075.
32. **Presentation of our organization** [<http://www.fci.be/en>]
33. [<https://www.akc.org/dog-breeds/>]
34. Collins LM, Asher L, Summers J, McGreevy P: **Getting priorities straight: risk assessment and decision-making in the improvement of inherited disorders in pedigree dogs.** *Vet J* 2011, **189**(2):147-154.
35. Mellanby RJ, Ogden R, Clements DN, French AT, Gow AG, Powell R, Corcoran B, Schoeman JP, Summers KM: **Population structure and genetic heterogeneity in popular dog breeds in the UK.** *The Veterinary Journal* 2013, **196**(1):92-97.
36. Bell JS: **The Ins and Outs of Pedigree Analysis, Genetic Diversity, and Genetic Disease Control.** In: *Tufts' Canine and Feline Breeding and Genetics Conference: 2003; North Graton, MA; 2003.*
37. Bannasch D, Safra N, Young A, Karmi N, Schaible RS, Ling GV: **Mutations in the SLC2A9 gene cause hyperuricosuria and hyperuricemia in the dog.** *PLoS genetics* 2008, **4**(11):e1000246-e1000246.
38. Asher L, Diesel G, Summers JF, McGreevy PD, Collins LM: **Inherited defects in pedigree dogs. Part 1: Disorders related to breed standards.** *The Veterinary Journal* 2009, **182**(3):402-411.
39. The Council On E, Judicial Affairs AMA: **Multiplex Genetic Testing.** *Hastings Center Report* 1998, **28**(4):15-21.
40. Risks IoMUCoAG: **Genetic Testing and Assessment.** In: *Assessing Genetic Risks: Implications for Health and Social Policy.* Edited by Andrews LB FJ, Holtzman NA, et al. Washington (DC): National Academies Press (US); 1994.
41. Kuo FC, Mar BG, Lindsley RC, Lindeman NI: **The relative utilities of genome-wide, gene panel, and individual gene sequencing in clinical practice.** *Blood* 2017, **130**(4):433-439.
42. **Overcoming the Challenges of Multiplex PCR** [<https://www.biocompare.com/Editorial-Articles/117895-Multiplex-PCR/>]
43. Ke X, Kennedy LJ, Short AD, Seppälä EH, Barnes A, Clements DN, Wood SH, Carter SD, Happ GM, Lohi H *et al*: **Assessment of the functionality of genome-wide canine SNP arrays and implications for canine disease association studies.** *Animal Genetics* 2011, **42**(2):181-190.
44. **DNA testing & simple inherited disorders** [<https://www.thekennelclub.org.uk/health/for-breeders/dna-testing-simple-inherited-disorders/>]
45. Inthorn J: **Genetic risk information.** *Journal of Risk Research* 2018, **21**(2):109-116.
46. Evans JM, Noorai RE, Tsai KL, Starr-Moss AN, Hill CM, Anderson KJ, Famula TR, Clark LA: **Beyond the MHC: A canine model of dermatomyositis shows a complex pattern of genetic risk involving novel loci.** *PLoS genetics* 2017, **13**(2):e1006604.
47. Lacy RC: **Importance of genetic variation to the viability of mammalian populations.** *Journal of Mammalogy* 1997, **78**(2):320-335.
48. Booy G, Hendriks RJJ, Smulders MJM, Van Groenendael JM, Vosman B: **Genetic Diversity and the Survival of Populations.** *Plant Biology* 2000, **2**(4):379-395.
49. Kanthaswamy S, Oldt R, Montes M, Falak A: **Comparing two commercial domestic dog (Canis familiaris) STR genotyping kits for forensic identity calculations in a mixed-breed dog population sample.** *Animal genetics* 2019, **50**(1):105-111.
50. Rothschild MFS, L.; and Lamont, S.J.: **The Major Histocompatibility Complex and its Role in Disease Resistance and Immune Responsiveness.** In. Edited by Publications AS; 2000: 414.

51. Sommer S: **The importance of immune gene variability (MHC) in evolutionary ecology and conservation.** *Front Zool* 2005, **2**:16-16.
52. Kennedy LJ, Barnes A, Short A, Brown JJ, Lester S, Seddon J, Fleeman L, Francino O, Brkljacic M, Knyazev S *et al*: **Canine DLA diversity: 1. New alleles and haplotypes.** *Tissue antigens* 2007, **69** Suppl 1:272-288.
53. Radwan J, Biedrzycka A, Babik W: **Does reduced MHC diversity decrease viability of vertebrate populations?** *Biological Conservation* 2010, **143**(3):537-544.
54. Brown E, Young A, Wolf Z, Wade CM, Hughes A, Foreman O, Jayashankar K, Oberbauer A, Safra N, Lindblad-Toh K *et al*: **Juvenile Hypoadrenocorticism in the Nova Scotia Duck Tolling Retriever: A recessive monogenic autoimmune disease.** In: *2016 American College of Veterinary Internal Medicine Forum: 2016; Denver, Colorado: Journal of Veterinary Internal Medicine; 2016: 1407-1519.*
55. **Juvenile Addison's Disease** [<https://www.ofa.org/diseases/dna-tested-diseases/juvenile-addisons-disease#:~:text=Nova%20Scotia%20Duck%20Tolling%20Retriever%20ONLY&text=Addison's%20disease%20can%20occur%20in,of%20onset%20of%204%20years.&text=The%20average%20age%20of%20puppies,of%20age%20have%20been%20identified.>]
56. Bunel M, Chaudieu G, Hamel C, Lagoutte L, Manes G, Botherel N, Brabet P, Pilorge P, André C, Quignon P: **Natural models for retinitis pigmentosa: progressive retinal atrophy in dog breeds.** *Human Genetics* 2019, **138**(5):441-453.
57. Mellersh CS, Bournnell MEG, Pettitt L, Ryder EJ, Holmes NG, Grafham D, Forman OP, Sampson J, Barnett KC, Blanton S *et al*: **Canine RPGRIP1 mutation establishes cone-rod dystrophy in miniature longhaired dachshunds as a homologue of human Leber congenital amaurosis.** *Genomics* 2006, **88**(3):293-301.
58. Das RG, Marinho FP, Iwabe S, Santana E, McDaid KS, Aguirre GD, Miyadera K: **Variabilities in retinal function and structure in a canine model of cone-rod dystrophy associated with RPGRIP1 support multigenic etiology.** *Scientific Reports* 2017, **7**(1):12823.
59. Zeng R, Coates JR, Johnson GC, Hansen L, Awano T, Kolicheski A, Ivansson E, Perloski M, Lindblad-Toh K, O'Brien DP *et al*: **Breed distribution of SOD1 alleles previously associated with canine degenerative myelopathy.** *Journal of veterinary internal medicine* 2014, **28**(2):515-521.
60. Amorim CEG, Gao Z, Baker Z, Diesel JF, Simons YB, Haque IS, Pickrell J, Przeworski M: **The population genetics of human disease: The case of recessive, lethal mutations.** *PLoS genetics* 2017, **13**(9):e1006915.
61. Karlsson LMSNE: **Pet genomics medicine runs wild.** In: *Nature*. 2018: 470-472.
62. Zhang S: **What vets think of '23andMe for dogs'.** In: *The Atlantic*. 2018.
63. **Genetic Health Screening for Dogs** [<https://www.whole-dog-journal.com/behavior/instincts-dna/genetic-health-screening-for-dogs/>]
64. Lewis TW, Mellersh CS: **Changes in mutation frequency of eight Mendelian inherited disorders in eight pedigree dog populations following introduction of a commercial DNA test.** *PLoS one* 2019, **14**(1):e0209864-e0209864.
65. Gao Z, Waggoner D, Stephens M, Ober C, Przeworski M: **An Estimate of the Average Number of Recessive Lethal Mutations Carried by Humans.** *Genetics* 2015, **199**(4):1243.
66. Indrebø A: **Animal welfare in modern dog breeding.** *Acta Veterinaria Scandinavica* 2008, **50**(Suppl 1):S6-S6.
67. Rongxing W, Junhua Y: **DNA Contamination and Treatment Countermeasures in Dog DNA Testing Laboratory.** *Animal Husbandry and Feed Science* 2017, **9**(6):352-354.
68. **The Benefits and Pitfalls of DNA Tests** [<https://animallaw.foxrothschild.com/2017/02/26/the-benefits-and-pitfalls-of-dna-tests/>]
69. Rimoin DL: **The American College of Medical Genetics, the first 20 years.** *Genetics in Medicine* 2011, **13**(3):179-187.

70. Shaffer LG, Sundin K, Geretschlaeger A, Segert J, Swinburne JE, Royal R, Loechel R, Ramirez CJ, Ballif BC: **Standards and guidelines for canine clinical genetic testing laboratories.** *Human Genetics* 2019, **138**(5):493-499.
71. Horton R, Crawford G, Freeman L, Fenwick A, Wright CF, Lucassen A: **Direct-to-consumer genetic testing.** *BMJ* 2019, **367**:l5688.
72. Lachance CR, Erby LAH, Ford BM, Allen VC, Kaphingst KA: **Informational content, literacy demands, and usability of websites offering health-related genetic tests directly to consumers.** *Genetics in Medicine* 2010, **12**(5):304-312.
73. Pardo-Seco J, Martín-Torres F, Salas A: **Evaluating the accuracy of AIM panels at quantifying genome ancestry.** *BMC Genomics* 2014, **15**(1):543.
74. **How accurate are online DNA tests?** [<https://www.scientificamerican.com/article/how-accurate-are-online-dna-tests/>]
75. Wolf ZT, Leslie EJ, Arzi B, Jayashankar K, Karmi N, Jia Z, Rowland DJ, Young A, Safra N, Sliskovic S *et al*: **A LINE-1 Insertion in DLX6 Is Responsible for Cleft Palate and Mandibular Abnormalities in a Canine Model of Pierre Robin Sequence.** *PLoS genetics* 2014, **10**(4):e1004257.
76. Gregoire Leroy BNB, Katariina Maki.: **Genetic testing can aid pet breeding.** *Nature* 2018, **562**:1.
77. Deane-Coe PE, Chu ET, Slavney A, Boyko AR, Sams AJ: **Direct-to-consumer DNA testing of 6,000 dogs reveals 98.6-kb duplication associated with blue eyes and heterochromia in Siberian Huskies.** *PLoS genetics* 2018, **14**(10):e1007648-e1007648.
78. Donner J, Anderson H, Davison S, Hughes AM, Bouirmane J, Lindqvist J, Lytle KM, Ganesan B, Ottka C, Ruotanen P *et al*: **Frequency and distribution of 152 genetic disease variants in over 100,000 mixed breed and purebred dogs.** *PLoS genetics* 2018, **14**(4):e1007361.
79. Dettelleux J: **A Leaky Noisy-OR Bayesian Network Applied to Genetic Counseling in Dogs.** *Animals* 2020, **10**(6):1104.
80. Gershony LC, Belanger JM, Short AD, Le M, Hytönen MK, Lohi H, Famula TR, Kennedy LJ, Oberbauer AM: **DLA class II risk haplotypes for autoimmune diseases in the bearded collie offer insight to autoimmunity signatures across dog breeds.** *Canine genetics and epidemiology* 2019, **6**(1):2.
81. Kennedy LJ, Barnes A, Short A, Brown JJ, Seddon J, Fleeman L, Brkljacic M, Happ GM, Catchpole B, Ollier WE: **Canine DLA diversity: 3. Disease studies.** *Tissue antigens* 2007, **69 Suppl 1**:292-296.
82. Kennedy LJ, Ollier WER, Marti E, Wagner JL, Storb RF: **Canine Immunogenetics.** In: *The Genetics of the Dog*. 2nd edn. Edited by Ostrander EA, Ruvinsky A. London: CAB International; 2012: 91-126.
83. Wilbe M, Sundberg K, Hansen IR, Strandberg E, Nachreiner RF, Hedhammar A, Kennedy LJ, Andersson G, Björnerfeldt S: **Increased genetic risk or protection for canine autoimmune lymphocytic thyroiditis in Giant Schnauzers depends on DLA class II genotype.** *Tissue antigens* 2010, **75**.